

2X2

ADVENTURE BIKE

USER MANUAL

2X2ADV V2.4



KIA ORA¹ HELLO.

UBCO was born in New Zealand, proudly designed, prototyped, and tested here, so we've included some of our unique language to keep it Kiwi. You'll find a Glossary on page 6 to explain what it all means.

Registration Information

Fill in your vehicle and contact information below. Attach your receipt of purchase within this book for safekeeping.

Important: Please also go online: www.ubco.com/register to send us your registration information; both are required for any future warranty claims.

MODEL CODE	VIN No.*	
DATE OF SALE	LICENCE PLATE No.	
DEALER NAME (or website if purchased online)		
OWNER'S NAME		
PHONE NUMBER		
ASSEMBLED BY (print & sign name)		DATE ASSEMBLED
<input type="checkbox"/> CHECK THIS BOX ONCE THE ABOVE INFORMATION HAS BEEN REGISTERED ONLINE		

*Your VIN number is engraved on the right-hand side of the frame head tube.

TABLE OF CONTENTS

Glossary	6
01 YOUR BIKE	8
Parts Overview	11
Technical Information	12
UBCO App	13
Handlebar Parts	14
LCD Display	18
Handlebar Controls	20
Adjustable Suspension	24
Pre-ride Inspection	27
Accessory Lugs	28
02 YOUR POWER SUPPLY	32
Charging Your Power Supply	36
Removing the Power Supply	38
Power Supply Care & Safety	40
03 SAFETY	42
Riding Safety	44
Loading the 2X2	46
04 MAINTENANCE & CARE	50
Your Field Kit	53
Replacing Key Fob Battery	53
Wheels	54
Replacing Brake Pads	56
Cleaning the Bike	57
06 TROUBLESHOOTING	58
Fault Codes	62
07 FINE PRINT	66
Limited Warranty	69
Servicing Schedules	74

YOU BEAUTY!²

Thanks for buying an UBCO 2X2. This manual will help you get the best out of your bike and is chocka³ full of handy tips. Keep it tucked inside the Field Kit under your bike seat, that way it will always be there if you need it – even if you're out in the wop-wops⁴.

First things first:

Go online to www.ubco.com/register to register your bike with us. This ensures we know about your purchase but also keeps a record with the bike if it's ever sold.

Next:

Download the free UBCO App from your smartphone's app store. Simply search UBCO. Find out more about the app on page 13.

Then:

Read this manual carefully. Pay special attention to the safety messages that appear throughout. This manual should be considered a permanent part of the 2X2 and should remain with your bike if it is resold. Chur.⁵

 **When you see this symbol, the information following is important for safety and proper function of the 2X2.**



About NZ

Here's a map of New Zealand (just in case it's missing off your nearest world map...).

Up north you'll find a 90km long beach. Down south there's a whole lot of mountains. And in between (you might call it Middle-earth⁶) we've got rivers and lakes, farms and forests, volcanoes, earthquakes, caves, beaches, a few cities, and a whole lot of birds.

Find out more about our beautiful country and some of her native residents on the pages of this book. There's also a few fun facts to help out on Trivia Night.

Enjoy!

Glossary

- 1 Kia Ora** PAGE 1
Māori for hello, cheers, good luck, or best wishes.
- 2 You Beauty** PAGE 4
A general exclamation of happiness and joy.
- 3 Chocka** PAGE 4
Short for chock-a-block.
- 4 Wop-wops** PAGE 4
A far away place, otherwise known as the middle of nowhere.
- 5 Chur** PAGE 4
Short for cheers or thank you.
- 6 Middle-earth** PAGE 5
The fictional setting for many of JRR Tolkien's works, including the *Lord of the Rings* film trilogy, which was filmed in NZ.
- 7 Get amongst it** PAGE 8
To throw oneself into doing something, especially a leisure activity or something physical.
- 8 Get cracking** PAGE 10
Act quickly and decisively.
- 9 Tiki Tour** PAGE 32
A sight-seeing journey with no particular destination in mind.
- 10 Hard yards** PAGE 34
A great deal of effort or hard work.
- 11 Go hard out** PAGE 42
To do something to its fullest; do something well.
- 12 Sweet as** PAGE 42
Wonderful, extremely good.
- 13 She'll be right** PAGE 50
It will be all right; don't worry.
- 14 Ages** PAGE 50
A long time.
- 15 Got your gumboots stuck** PAGE 58
Got into trouble.

World Famous in New Zealand

1. New Zealand has many unique native fish, insects, birds, lizards, and frogs. Our only native mammals are bats and marine mammals.
2. There are no snakes in NZ. None.
3. There are also no nuclear power stations in NZ.
4. In 1893, NZ became the first self-governing country in the world to give women the right to vote.
5. In 1953, Kiwi Sir Edmund Hillary was the first person to summit Mount Everest, along with Sherpa Tenzing Norgay.
6. NZ has more golf courses per capita than anywhere else in the world.
7. The first commercial bungee jump was made by A J Hackett in the Kawarau Bridge in Queenstown, back in 1988. It still operates there today.
8. Our capital city, Wellington, is the southernmost capital in the world.
9. No matter where you are in NZ, you're never more than 128 km (80 miles) from the seaside.
10. The Hawke's Bay is home to a hill with the longest place name found in any English-speaking country. The hill's 85 character long Māori name is: Taumatawhakatangihangakoauauotamateaturipuka kapikimaungahoronukupokaiwhenuakitanatahu, which roughly translates to: "the place where Tamatea, the man with the big knees, who slid, climbed and swallowed mountains, known as the land-eater, played his nose flute to his loved ones."

GET TO KNOW THE 2X2

01 YOUR BIKE

Two wheels, two motors, no gas, no noise. All set for work or adventure. Get amongst it!⁷

MEET THE LOCALS: Kiwi

Up to the size of a domestic chicken, kiwi are the smallest living ratites (same group as ostriches, emus, and cassowaries). They are nocturnal, have hair-like feathers, and cannot fly.

The New Zealand people were nicknamed Kiwis during WWI.



Welcome to your UBCO 2X2 Adventure Bike.

The UBCO 2X2 is a two-wheel-drive utility electric vehicle (UEV) and is inherently different from other motorcycles and e-bikes.

Before you ride, ensure you've read this manual and are familiar with how to use the bike and the proper safety precautions. Always wear a helmet.

Once you've educated yourself and are ready to get cracking⁸, start her up and GO!!!

Bike Parts

- A** Handlebar Controlspage 20
- B** Steering Lockpage 23
- C** Rear Rack
- D** Accessory Lugspage 28
- E** Front Rack
- F** Rear Suspensionpage 24
- G** Front Suspensionpage 25
- H** Power Supply Lockpage 38
- I** Power Supplypage 32
- J** Power Plug.....page 38
- K** Kickstand.....page 22
- L** Hub Motors

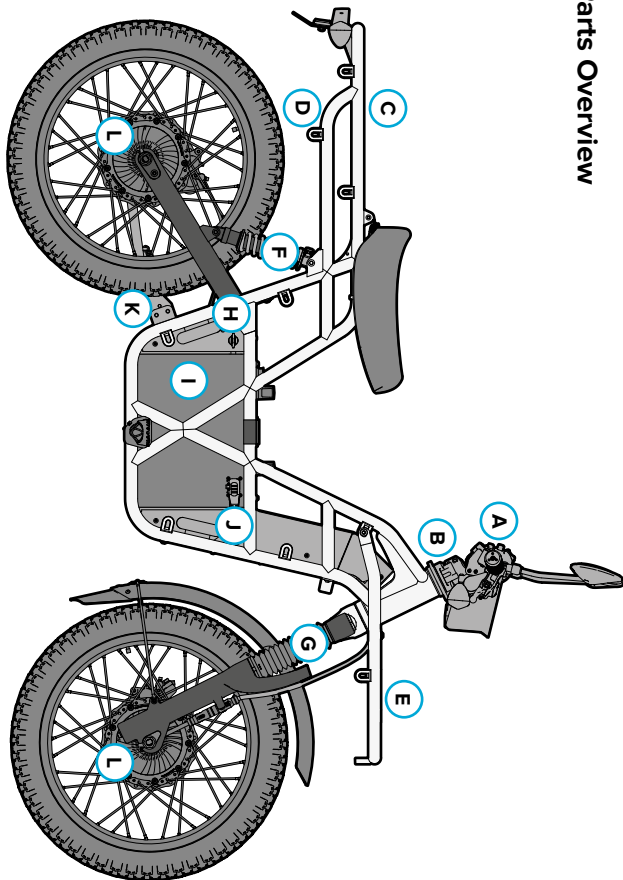

Technical Information

SPECIFICATIONS

Weight (excl power supply)	52.7kg	116lbs
Height	1,040mm	41"
Seat height	815mm	32"
Width (handlebars)	820mm	32.3"
Length	1,820mm	72"
Wheelbase	1215mm	47.8"
Max speed	50km/h (EU 45km/h limited)	30mph
Drive train	2 x 1kW Flux ² motors	
Payload (incl rider)	150kg	330lbs
Suspension - front	UBCO ATFZ 130mm adjustable	
Suspension - rear	UBCO ATF 120mm adjustable	

VEHICLE CLASS

NZ: LA (moped)	Learner license or higher.
AU: LA (moped)	State dependent; provisional or motorcycle license.
US: Motor driven cycle/moped	Dependent on state laws.
EU: L1e-B	Dependent on country laws.

Note: Check your local licensing laws to determine license requirements.

All information in this publication is based on the latest production information available at the time of approval for printing. UBCO Ltd reserves the right to make changes at any time without notice.

UBCO App

Before you ride, download the UBCO App from your smartphone's app store. Be sure to keep your app updated and it will, in turn, keep your bike up to date.

Be sure you have Bluetooth and location services enabled on your phone and your 2X2 is turned on and in range before opening the app.

The icons along the bottom of the screen reference the following functions:



LIVE DASH

View your speed, power supply charge, power output or regen input, and motor temperature. If you have a phone mount, you can check your dash while you ride.



HOME

Get a quick overview of your bike's status and settings, such as power supply level and motor temperatures. Tap the menu to add a device or go to another page.



SETTINGS

Enable riding modes and control features such as regenerative braking. Turn all the lights off (formerly Hunting Mode) and change the units of measure.

Handlebar Parts

1. Rear brake.....page 21
2. Control switch..... page 20
3. LCD display.....page 18
4. Steering lockpage 23
5. Kill switch..... page 20
6. Throttle.....page 21
7. Front brakepage 21

⚠ The 2X2 is very quiet due to its electric drive motors and will not rev when it is turned to RUN mode or when the throttle is turned.

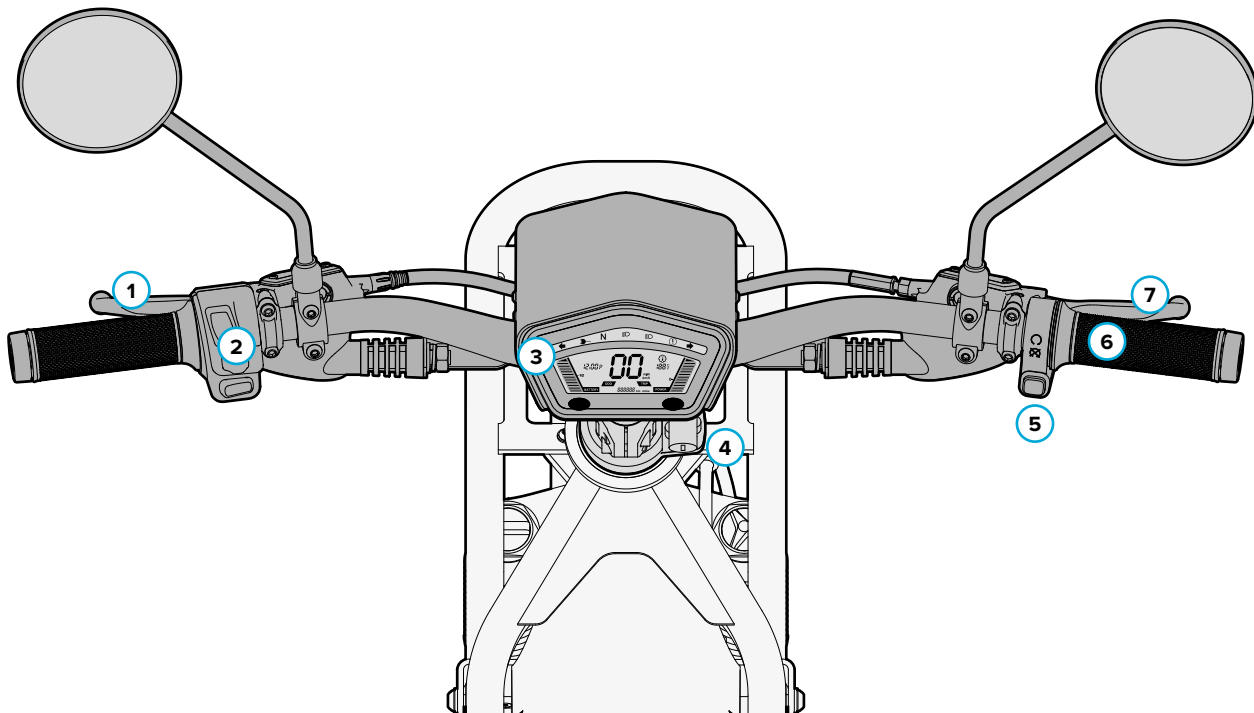

Your Keys

Each 2X2 comes with two types of keys: a key fob and a securing key. The key fob is used to turn the bike on or off, while the securing key activates the steering lock and the power supply lock.

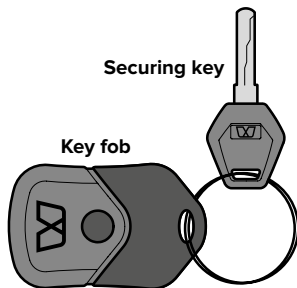

Powering the Bike

The key fob will turn the 2X2 on but the kill switch is used to change between ACC and RUN modes.

ACC mode: The LCD display will turn on but the throttle is inactive.

RUN mode: Throttle is activated and the lights turn on.

- ⊙ Hold the key fob button 1.5 seconds to turn the bike on in ACC mode. The display will turn on and N is illuminated.
- ⊙ If you're ready to ride, straddle the bike and retract the kickstand, then press the kill switch to enable RUN mode. The headlight will turn on. Twist the throttle towards you to go.
- ⊙ Once stopped, press the kill switch to turn the bike back to ACC.
- ⊙ To turn bike off from ACC, hold the key fob button for 1 second or hold the kill switch for 2 seconds.
- ⊙ To turn bike off from RUN mode, hold either the key fob or the kill switch button for 2 seconds.

Security Mode

Security Mode determines whether the key fob is required to power the bike. Security Mode is on by default, meaning the key fob is required to turn the bike on.

To turn Security Mode OFF:

This enables the bike to be powered without the key fob; the bike is only turned on using the kill switch.

⚠ Turning off Security Mode will allow anyone with access to the bike to turn it on and use it.

This process can only be performed using a fob that is already paired to the bike.

1. Turn off the bike.
2. Press and hold both the key fob button and the kill switch for approximately 10 seconds.
3. The bike will beep a few times while the buttons are held and then give one final long beep to indicate programming is complete.
4. The bike can now be turned on using only the kill switch.

To turn Security Mode back on, repeat the above steps.

LCD Display

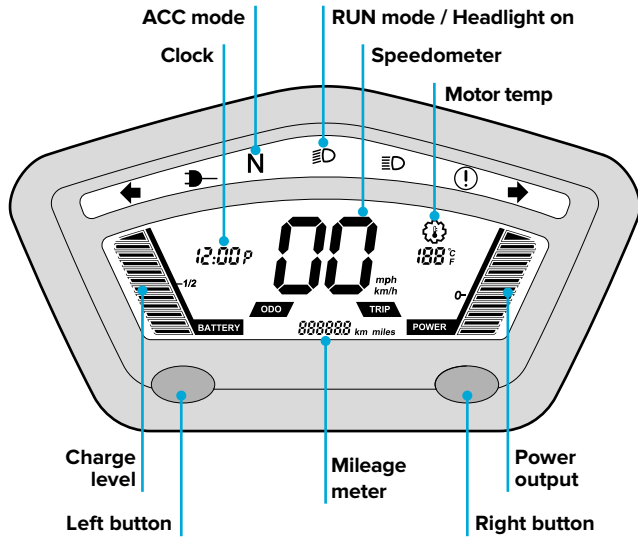

- | | |
|------------------------------|----------------------------------|
| ◀ Left indicator | ▶ Right indicator |
| 🔌 Charge required | ⚠ Warning |
| ☞ Lights on / Lo beam | ODO Odometer displayed |
| ☞ Lights on / Hi beam | TRIP Trip meter displayed |

Warning Light

If there is a system issue, the warning light will flash and an error code will be displayed in the odometer area. Find more information in the UBCO App and see common fault codes on page 62.

Charge Level

The charge level is calculated using coulomb counting. Accurate state of charge (SOC) is displayed on the left side of the display, split into 12 segments. The charge level is split up into 12 segments with a halfway indicator between the 6th and 7th segments. The charge required indicator will light up when power supply SOC is getting low.

Power Output Meter

This displays the real-time power output to the motors. Any bars shown above the 0 mark represent power output to the motors and any bars shown under the 0 mark represent power input to the power supply through regenerative braking.

Odometer and Trip Meter

To select between odometer (ODO) and trip meter (TRIP) view, press the left button. To reset the trip meter, press the left button for 8 seconds.

Switch from Metric to Imperial

To select between metric and imperial units for the speed, odometer, and trip meter, while ODO is showing, hold down the left button.

To change between Celsius and Fahrenheit, press the right button on the display.

To Change the Clock

- Hold down the right button until the time starts flashing.
- Press the right button to change between hours and minutes.
- Press the left button to cycle through numbers.
- Hold the right button until the numbers stop flashing to set the time.

Handlebar Controls

Control Switch

On the left side of the handlebar you will find a control switch:

1. Headlight
2. Indicators
3. Horn

The headlight and tail lights automatically come on when the 2X2 is in RUN mode.

To turn off the headlight, either switch the 2X2 to ACC mode using the key fob, open the UBCO App and switch off "LIGHTS" on the settings screen, or hold the low beam switch until it turns off (hold again to turn back on).

The high beam function

of the headlight can be activated in ACC mode for when temporary lighting is required when the throttle is inactive. Do not use the high beam setting against oncoming traffic.

Kill Switch

On the right side of the handlebar, next to the throttle, is the kill switch for the motors (4).

When the kill switch is activated, the bike will change to ACC mode and N shows on the LCD display.

To ensure the 2X2 can be ridden, retract the kickstand and press the kill switch to deactivate it (RUN mode).

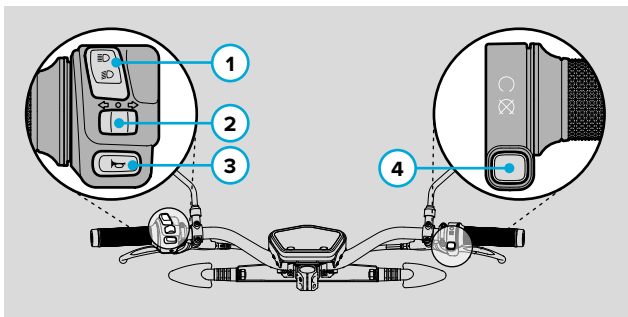

Throttle

To accelerate, twist the throttle towards you. There are no gears or clutch, so the throttle controls all acceleration from start to top speed (excluding gravity).

To maintain a constant speed, hold the throttle in a constant position. If you let go of the throttle, the 2X2 will start to decelerate.

Note: Do not continuously power the throttle when the 2X2 is held stationary.

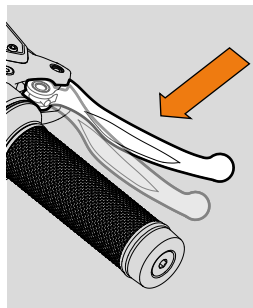
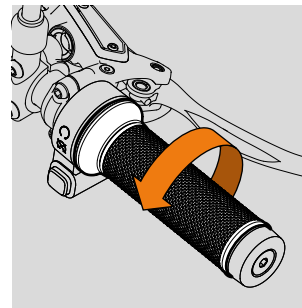

Tip: The brake lever angle can be adjusted to your preference using the screws on the brake lever mount. Ensure they're re-tightened to 7Nm torque setting.

Brake

To slow down, allow the throttle to return to neutral position and then apply the brakes: left = rear, right = front.

The drive motors provide a level of regenerative braking that assist in slowing down the 2X2.

- ⊙ The first level of regenerative braking automatically activates when the throttle is returned to neutral. This provides a level of braking similar to engine braking.
- ⊙ The second level of regenerative braking activates when the brake lever is pulled. This provides a higher level of braking and assists the mechanical brakes.

Bedding-in the Brakes

For optimum brake performance with new bikes and brake pads, we recommend doing a series of 10 sequential, firm braking efforts from 40kph to 5kph in a controlled environment. This will ensure that the brake pad material is sufficiently deposited onto the rotor, improving the total braking force available, as well as resistance to over-heating.

Kickstand

The kickstand is retracted manually but has a switch so the 2X2 cannot be ridden with the stand down. The kickstand must be retracted before the throttle can be activated.

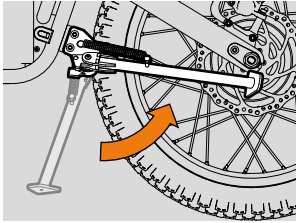

Steering Security Lock

The 2X2 has a steering lock to fix the steering angle of the bike when it's parked. This makes the 2X2 very difficult to wheel away as it will only turn in circles.

The steering lock is located on the right side of the steering tube just below the handlebars. The lock is activated with the securing key.

To activate/deactivate the steering lock:

- a. Turn the handlebars counter-clockwise (towards the left) until the lock body lines up with the securing ring on the head tube.
- b. Put the securing key in and turn clockwise to activate the lock.
- c. Unlock the steering by turning the key counter-clockwise; use the steering as per normal.

It is important to ensure the steering lock is disengaged and the securing key is removed before starting the 2X2.

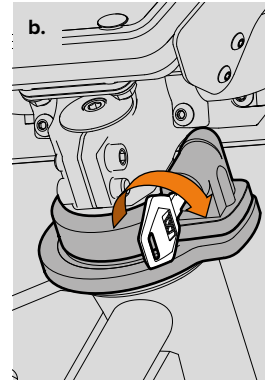
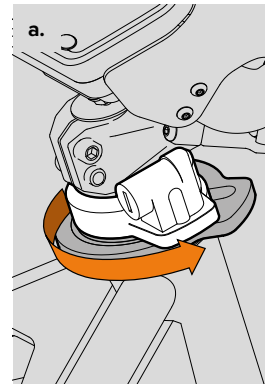

Adjustable Suspension

The front and rear suspensions have adjustable rebound controls that change the rate the suspension re-extends after an impact. They also feature spring preload adjustment that are helpful for setting the loaded ride height of the vehicle and help determine the suspension's ability to prevent bottoming out (AKA setting the Sag).

These adjustments allow the rider to set the loaded ride height for various use cases and terrains to improve the handling and capability of the vehicle. For more demanding terrain, or higher load carrying capacity, we recommend increasing the preload to prevent harsh bottom out forces.

See recommendations for various riding situations on the following page.

Front:

Rebound speed is adjusted on the right-hand side of the fork crown. Twist the dial clockwise to slow the rebound; counter-clockwise to speed it up.

On the left side of the fork, the spring preload is adjusted. Twist the dial clockwise to lessen the spring force; counter-clockwise will increase the spring force.

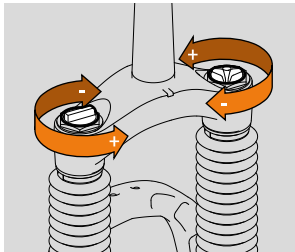
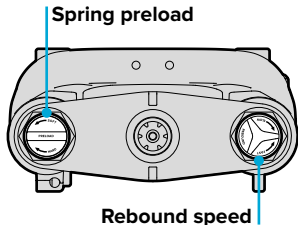

Rear:

Rebound control can be adjusted using the red dial at the top of the spring. Twist the dial counter-clockwise to slow the rebound; clockwise speeds it up (this is opposite to the front fork).

To adjust the rear spring preload, wind the disk at the base of the spring clockwise to lessen the spring force; twist counter-clockwise to increase the spring force.

The rear suspension preload and rebound controls should be set equally on both sides of the bike.

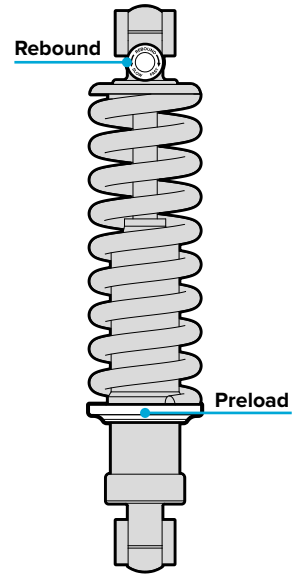
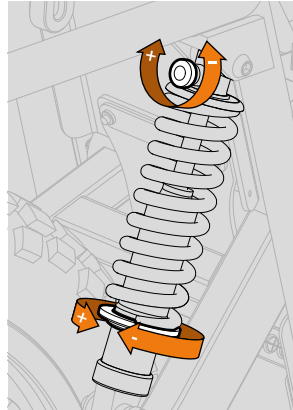

Suspension Recommendations

	FRONT REBOUND	FRONT SPRING	REAR REBOUND	REAR SPRING
On-road Rider only (90kg)	Max fast	Full soft	Max fast	20mm thread exposed
On-road + Load (125kg)	Max fast	1 full turn to hard	4 clicks towards slow	20mm thread exposed
Off-road Rider only (90 kg)	Max fast	Full soft	2 clicks towards slow	30mm thread exposed
Off-road + Load (125kg)	Max fast	1 full turn to hard	6 clicks towards slow	30mm thread exposed

Note: if riding on a hard surface while off-road, such as hard, dry ground or tracks, adjust the suspension to on-road settings.

Pre-ride Inspection

You should perform a pre-ride inspection each time you ride to ensure all parts are in full working order.

DO NOT operate the bike if it is materially defective in operation, damaged, or missing safety-related equipment.

Physically check off each of the following before you ride:

- Lights** – Ensure the headlights, rear light, brake light and directional indicators are working.
- Brakes** – Check they are operational and check the brake pad wear.
- Bedding-in** – Complete the process to bed-in the brakes before your first ride (see page 22).
- Mirrors** – Check they are adjusted for proper viewing and are not obstructed by any load you may be carrying.
- Horn** – Check it sounds.
- Loose nuts, bolts, or fixings** – Ensure all are done up correctly and are secure.
- Power supply** – Ensure there is enough charge to carry out your work or journey. Ensure the battery strap is secured tightly.
- Tyres** – Check the condition and pressure of the tyres. Tyres are interchangeable and can be swapped out if required (details in Section 06: Maintenance & Care).

Accessory Lugs

The 2X2 is unique in that it features accessory lugs that are strategically placed across the frame to provide maximum flexibility and adaptability.

The lugs use standard M8 nuts and bolts for attaching tie downs, mounts, and accessories.

Inside each lug is a cavity to hold an M8 nut in place, preventing it from spinning as the bolt is tightened or loosened.

The front rack is attached via two lugs at the front of the main frame (see below right). These lugs can be utilised for other attachments if the front rack is removed.



Rear view



Side view

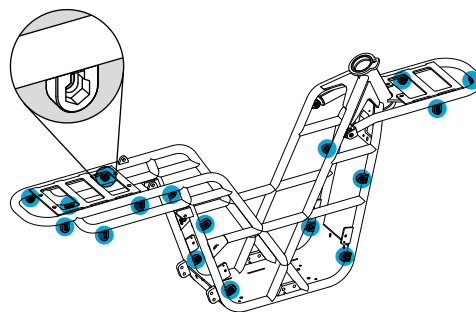

Lug Options

The 2X2 has 19 lug attachment points in total:

There are 17 points available with the front carrier attached (above);
16 when it is removed (below).

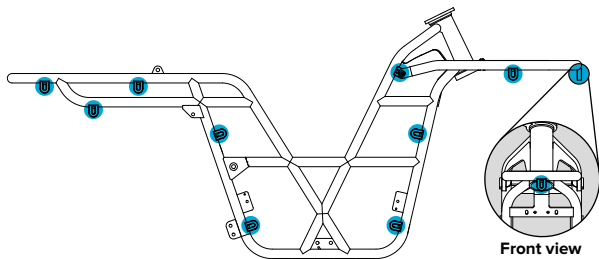

Front view

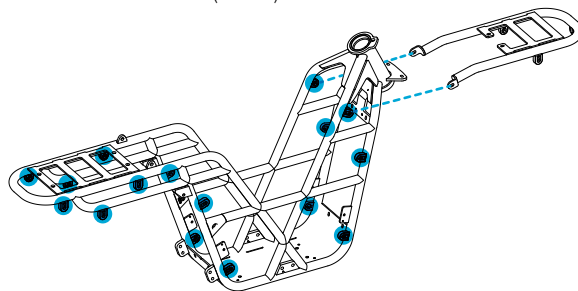

Here are some examples of how to use the accessory lugs. Follow the loading limits on page 46.

- a. The Rear Cargo Deck uses lugs on either side of the rear rack. The Front Cargo Deck also uses the lug on the end of the front rack.
- b. The UBCO Adapter Pack has brackets, nuts, bolts, and straps for attaching a tube to hold longer tools like a fishing rod or rake.
- c. Use the Adapter Pack L-brackets to attach a homemade deck or box to the front or rear rack.
- d. With the front rack removed, the two lugs

- near the console are available for attachments using the Adapter Pack.
 - e. Fairings attach to the frame's central lugs.
 - f. To attach an UBCO Pannier Frame, use three lugs on the side of the rear rack.
 - g. The Pannier Bag or Backpack then attaches to the Pannier Frame.
- These and other UBCO accessories, including the telematics unit, bike rack, and more are available from our website.

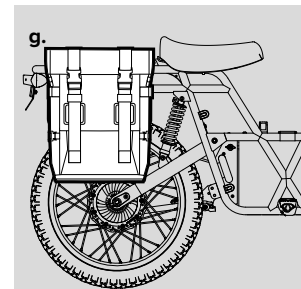
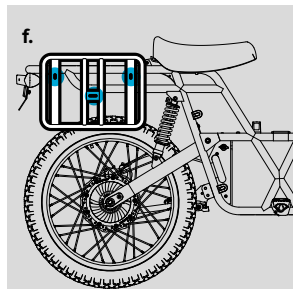
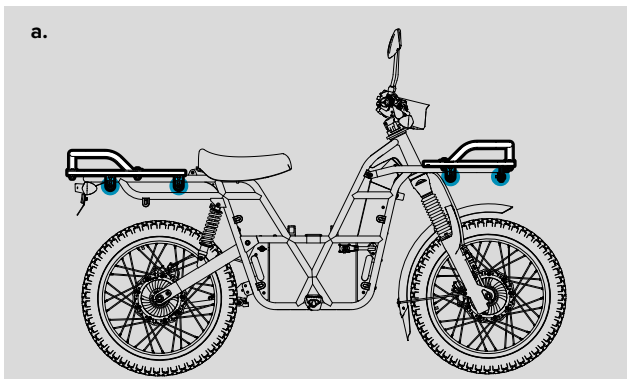
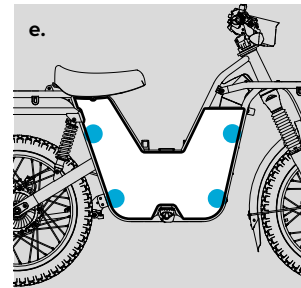
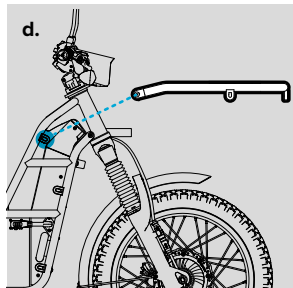
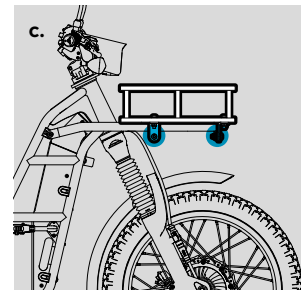
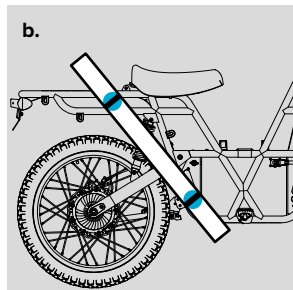

POWER YOUR RIDE

02 YOUR POWER SUPPLY

The lithium ion powerhouse super charges the 2X2. Tiki tour⁹ to your heart's content.

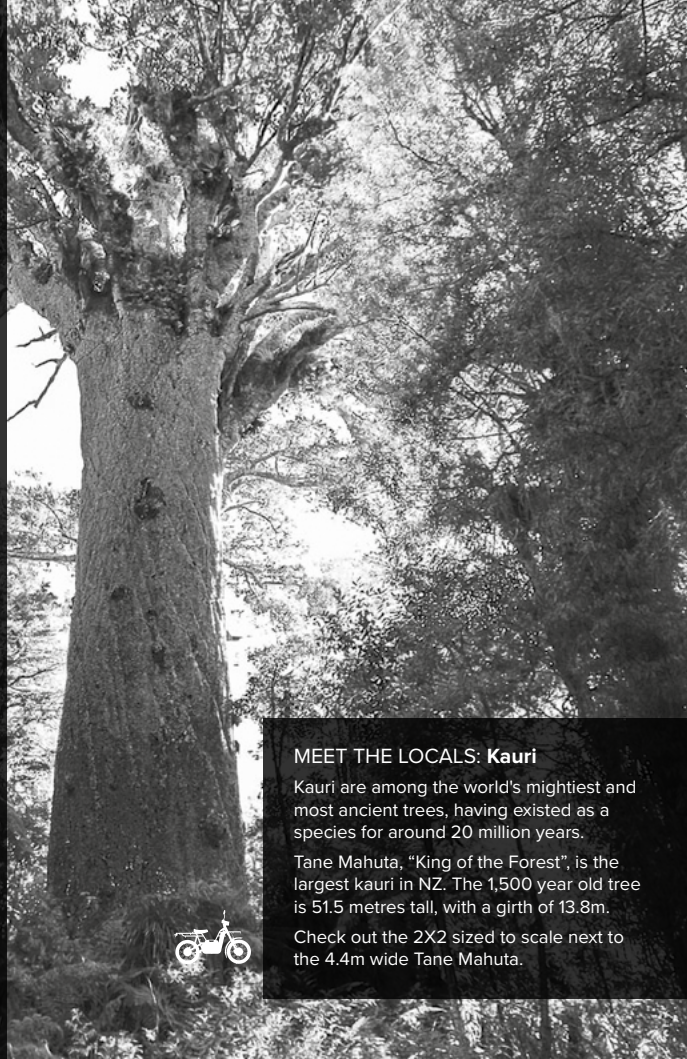

MEET THE LOCALS: **Kauri**

Kauri are among the world's mightiest and most ancient trees, having existed as a species for around 20 million years.

Tane Mahuta, "King of the Forest", is the largest kauri in NZ. The 1,500 year old tree is 51.5 metres tall, with a girth of 13.8m.

Check out the 2X2 sized to scale next to the 4.4m wide Tane Mahuta.

About Your Power Supply

The UBCO KXH power supply and connections are made to do the hard yards¹⁰. With an IP66 rating, the power supply is fully water and dust resistant. A solid work horse, the Li-ion power supply delivers a large capacity in a sturdy package.

Each KXH power supply is constructed from high quality LG 18650 Cylindrical Cells, mounted into cell holders, sealed within an alloy case, and screwed shut.

They are UN38.3 certified and the charger is UL/CE certified to provide safe operation, use, and transit. All this results in a robust power supply that can

handle the ride – and all the mud and dust.

When placing the power supply into the bike, ensure the main power output socket is located on the right-hand side of the power supply (when sitting on the 2X2). The charge port is located opposite side.

Be sure the plugs and ports are clean before attaching.

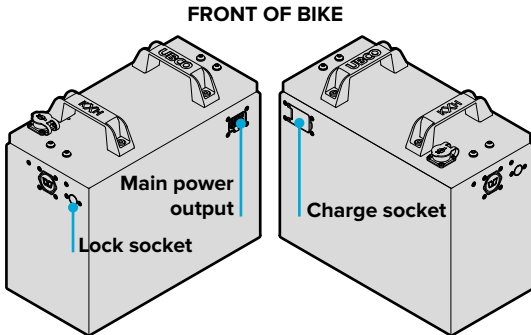

How far can I go?

Your range in a battery-powered vehicle is affected by similar variables to a combustion engine vehicle: carried weight, load, incline, speed, and terrain, among others.

The graphic below provides an easy to understand picture of how speed and efficiency affect range. The UBCO 2X2 is a high torque, low speed system, so its efficiency peaks below its top speed. The ranges expressed below are tested on closed asphalt testing tracks with an 80kg rider and are provided here for guidance only (*values based on Gen4 2X2 testing*).

- ⊙ Full speed (50km/h) at max throttle: Max distance 65km
- ⊙ Most efficient speed (32.5 km/h): Max distance 120km
- ⊙ At full speed with 80kg rider carrying an extra 37.2kg, range was reduced by 8.5%.
- ⊙ Compared to full speed range, repeated starting and stopping was tested to reduce range by only 3%.

2X2 BATTERY RANGE

Bike kept at constant speed with 80kg rider

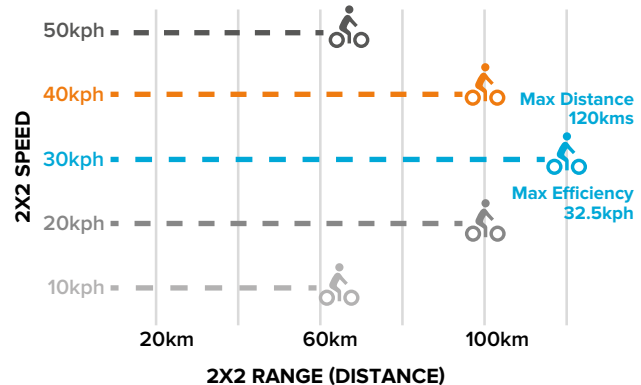

Values based on the Gen4 2X2 and 2.4kWh power supply

Charging Your Power Supply

Depending on the remaining charge, the power supply can take up to 6 hours to fully charge.

How to charge the power supply:

- a. Turn off the 2X2 using the key fob.
- b. Plug the charger into the charge socket on the power supply and twist to lock.
- c. Plug the provided charger into any standard wall socket and switch on at the wall (where required).
- d. The LED indicator lights on the charger will signal:
 - ⊙ **GREEN:** Power supply is fully charged
 - ⊙ **RED – Solid:** Charging as normal
 - ⊙ **RED – Flashing:** No power supply connected
 - ⊙ **BLUE – Solid:** Power supply voltage fault
 - ⊙ **BLUE – Flashing:** Reverse polarity.

If a charge error occurs, disconnect the charger from the power supply and wall socket. Reconnect. If flashing persists, contact your UBCO dealer.

When charging:

- ⊙ Keep away from any sparks or flames.
- ⊙ Install a smoke alarm near your charging area.
- ⊙ Do not charge if cables, charger, or power supply are damaged.
- ⊙ Use charger in dry, indoor conditions only and with adequate ventilation.

When finished charging: replace the waterproof cap over the charging socket on the power supply.

⚠ **Never store the power supply in an uncharged state. Doing so can void the warranty.**

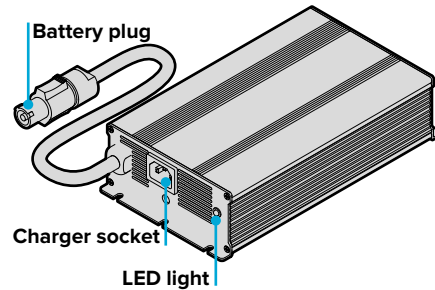

Checking Power Supply Charge

To check the capacity of your power supply, ensure it is plugged in to the 2X2 and press the key fob to turn the bike on. The charge meter on the left hand side of the LCD display will indicate the remaining charge.

Charge level is also available on the UBCO App. The yellow 'Charge Required' light at the top of the display will also illuminate when the remaining charge is low.

⚠ **To operate properly, the plug and sockets need to stay clean and in good condition.**
If the power supply is removed, ensure that the battery plug is reinstalled correctly.

Removing the Power Supply

The 2X2's power supply is interchangeable with other GenX5 KXH power supplies, meaning if you have more than one, you can swap them out to avoid charging downtime. Extra power supplies are available from UBCO Ltd or your UBCO dealer.

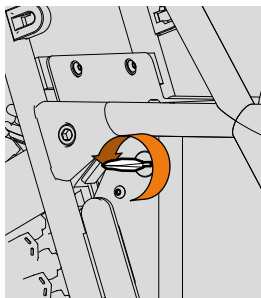

- a. Turn off the 2X2.
- b. Remove the battery strap and power plug.
- c. Using the securing key, unfasten the lock located on the rear right-hand side of the power supply.
- d. Lift the seat. Lift the power supply out of the 2X2 with two hands.
- e. Store on a stable, cool, dry surface.

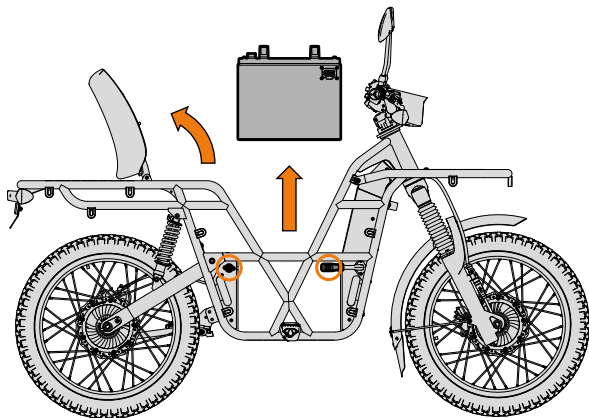

How long will my power supply last?

The KXH Power Supply uses automotive class LG cells. These are selected for their cyclic durability and safety. Power supply performance and lifespan is affected by a range of factors, from everyday usage to environmental conditions. For normal users, the power supply should last a significant period of time. The pack life is measured in 'discharge cycles'. The cells used are rated to retain 80% of their capacity after 800+ full discharge cycles (0-100%).

DISCHARGE CYCLES

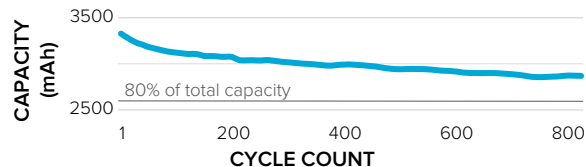

- ⊙ **Work Use:** Using the average distance travelled on farm each day of 25km at full speed over the course of a year, battery capacity could drop 20% over the course of about 5.5 years (~50,000km).
- ⊙ **Recreational Use:** Using the bike an average of 65km per week at full speed (~3,400km per year) battery capacity could drop 20% over the course of 15 years of use.

The cell performance will degrade in either high heat (60°C / 140°F) or very low temperatures (-17°C / 0°F).

UBCO will operate a take back program for the power supplies when they reach their end of life, where they will either be repurposed or recycled.

Power Supply Care & Safety

The lithium-ion power supply and charger are designed to work exclusively with the 2X2. Do not attempt to use any power supply or charger other than those supplied by UBCO. Extra batteries and chargers can be purchased from UBCO Ltd or your UBCO dealer.

- ⦿ Lithium-ion batteries do not suffer from the same charge memory problems as other batteries, therefore they can be topped up at any time.
- ⦿ Charge your power supply at least once a month to ensure its health.
- ⦿ Secure the power supply in place when riding.
- ⦿ Do not drop the power supply into the 2X2 from a height. Lower it into place carefully.
- ⦿ Do not submerge the power supply or the 2X2.
- ⦿ Store in a cool place indoors when not in use.
- ⦿ Do not burn the power supply or place it near heat sources above 80°C (176°F).
- ⦿ Keep away from children.
- ⦿ Do not attempt to open the power supply. This will void the warranty. If you have any issues, please contact your service provider.
- ⦿ Always charge your 2X2 indoors and at a temperature between 0-40°C (32°-104°F). Charging the power supply outside of this temperature range could damage your power supply or affect performance and life span.

- ⦿ As lithium is deemed a Class 9 Dangerous Good, the power supply must always be charged on a non-flammable surface (on a concrete floor, steel shelf, etc).
- ⦿ If storing for an extended period, ensure the power supply has between 50% and 90% charge. Storing the power supply with either full or too low a charge can cause cell damage, reducing its life.

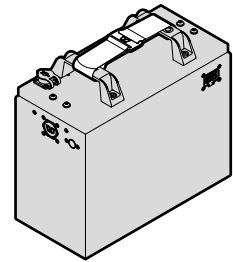

TOOL TIP: Attach the battery strap between the two handles to make an easy carrying strap.

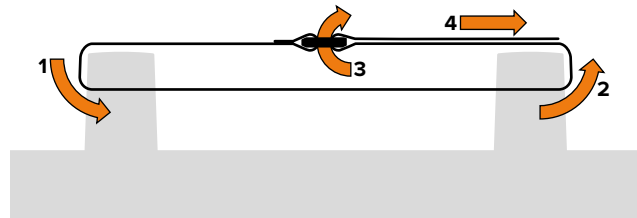

HAVE FUN SAFELY

03 SAFETY

We want you to have fun and go hard out¹¹, but the 2X2 is a powerful vehicle and should always be operated safely and with caution. Read our safety advice and you should be sweet as.¹²



MEET THE LOCALS: **Tuatara**

Tuatara are found only in New Zealand and are our largest reptile. They are the last survivors of an order of reptiles that thrived in the age of the dinosaurs.

Tuatara are unusual because they like cool weather. They do not survive well over 25°C but can live below 5°C, by sheltering in burrows.

Riding Safety

Due to its electric drive motors, the UBCO 2X2 is silent when on and very quiet in operation. When not in use, be sure to turn the bike off to prevent accidental activation of the throttle.

The electric drive eliminates many of the inherent safety concerns associated with internal combustion motorcycles.

- ⊙ A low centre of gravity makes the bike stable and able to maintain an upright position across sloping terrain.
- ⊙ Two wheel drive increases traction for a more stable ride.
- ⊙ No exhaust, no heat, and no fuel dramatically reduces the burn potential.
- ⊙ Weighing just 70kg (154lbs), the crush risk is low.
- ⊙ The easy to step through Super-X frame improves the safety of access and egress (particularly when loaded).
- ⊙ No chain, so no catching or entanglement issues.
- ⊙ Two-stage regenerative braking improves braking control.
- ⊙ Easy operation and simple display minimises rider distraction, but ensures you have all the information to stay in control.
- ⊙ With no emissions, the 2X2 is safer for the rider AND the environment.

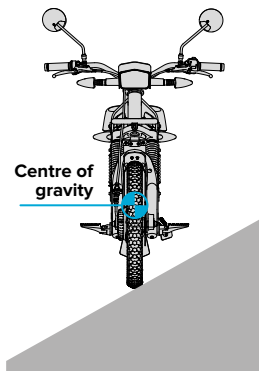

Please stay safe:

- ⊙ The 2X2 is nearly silent, always assume you are invisible to all other road and off-road users. Your life depends on it.
- ⊙ Be aware of your surroundings, other people, animals, and other vehicles. Ride to the conditions.
- ⊙ Ride the 2X2 within its loading and gradient limits as described in this section.
- ⊙ Follow your local road laws and regulations, both on- and off-road, and ride within your limits.
- ⊙ Never operate the 2X2 when fatigued, impaired, or under the influence of drugs or alcohol.
- ⊙ Wear a well-fitting helmet, securely fastened, that provides good visibility and meets law requirements.
- ⊙ Wear appropriate apparel such as close-toed shoes, gloves, and eye protection.
- ⊙ Only one person should ride on the 2X2 at any one time.
- ⊙ Children and/or inexperienced riders should NOT operate the 2X2.

On-road Safety

- ⊙ Watch for changes in traffic.
- ⊙ Check your blind spots and signal when turning or changing lanes. (Don't forget to turn off your indicator when you're finished turning or merging!)
- ⊙ Abide by your local riding laws, regulations, and posted speed limits.
- ⊙ Be mindful of other road users; never ride in a way that could cause harm to others.
- ⊙ Use your horn appropriately.
- ⊙ Extra care should be taken when riding in wet, frosty, and/or windy conditions, and when riding over road markings.

Loading the 2X2

Improperly loading your 2X2 can affect its stability and handling. Ride with caution when your 2X2 is loaded up. We recommend you do not exceed 150kg, including your body weight and cargo.

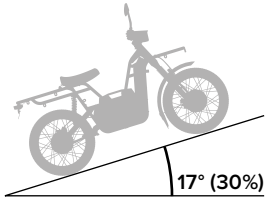

RIDER ONLY $\leq 100\text{kg}$

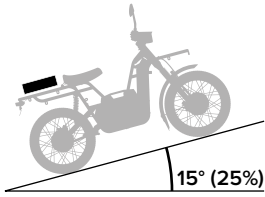

RIDER + CARGO $\leq 100\text{kg}$

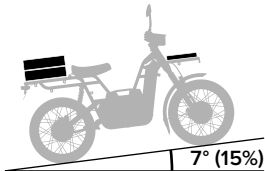

RIDER + CARGO 100-150kg

NOTE: These load limits are estimated suggestions based on testing. Each rider's abilities and limitations should be considered when loading up the 2X2.

- ⊙ With a load up to 100kg, the maximum gradient is 15° or 25%.
- ⊙ With loads exceeding 100kg, maximum and continuous gradients must be reduced accordingly.

Estimated limits for various gradients are illustrated here. For perspective, Baldwin Street in Dunedin, NZ is the world's steepest street at 19° or 35% – so don't be afraid to tackle those hills!

Loading Safety

- ⊙ Do not put your full weight on the kickstand. It is rated to support the 2X2 and a 50kg load. If load exceeds 50kg, support the 2X2 while loading.
- ⊙ Balance your load evenly.
- ⊙ Do not impede any moving parts on the 2X2.
- ⊙ Do not obscure lights, suspension, steering, or the view from your wing mirrors.

Maximum load recommendations:

- ⊙ Rear carrier: 40kg
- ⊙ Front carrier: 10kg
- ⊙ Body of the 2X2: 50kg

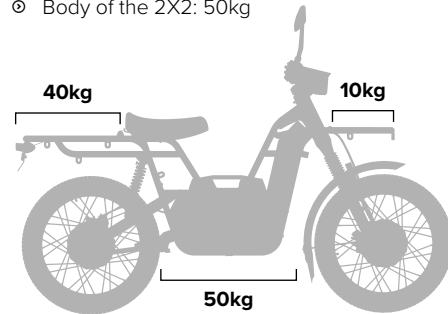

Off-road Safety

- ⊙ Watch for changes in terrain.
- ⊙ Abide by local off-road riding laws and regulations.
- ⊙ Obtain permission to ride on private property.
- ⊙ Use your horn as a warning signal where it's appropriate.
- ⊙ **Do not 'wee'ly' or jump the 2X2.** This can damage the hub motors, causing gear shock when the motor accelerates rapidly in the air and then decelerates instantly when it hits the ground again.

The UBCO 2X2 Adventure Bike is not designed to be a Motocross (MX) bike. Rather, it has been designed to be lighter and more functional. Using the 2X2 like an MX bike may damage the drive system and will likely void the warranty.

The power supply, motors, and electrical components are protected against mud, heavy rain, surface water, and shallow water crossings. They are not protected against submersion and the 2X2 should not ford water deeper than the axles.

If you are unsure about the type of riding you are doing, please check with your service provider or the team at UBCO and we can advise you.

Kickstand Safety

The UBCO 2X2 comes with a manually retracting kickstand. When retracting the kickstand, it is important to keep your legs and other body parts clear of the kickstand's path of movement.

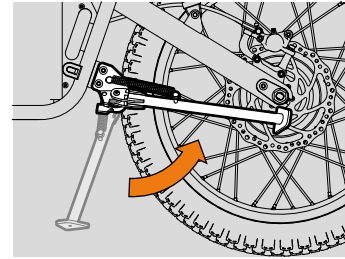

CARE FOR YOUR 2X2

04 MAINTENANCE & CARE

Don't just think, "She'll be right!"¹³
Take good care of your bike so
it will last for ages¹⁴.



MEET THE LOCALS: Kea

The world's only alpine parrot, the clever Kea can solve puzzles and use tools. They are unusual because they dig for food, nest on the ground, and breed in winter.

The cheeky Kea are known to attack sheep and even cars, prying the rubber seals off a car window.

Maintenance Obligations

Whilst UEV and portable power supplies have fewer moving parts than a combustion engine vehicles or technology, they still require maintenance to ensure their continued safe operation. Every product will need scheduled maintenance and care to ensure your warranty is maintained. This will increase the product's lifespan and reduce lifetime maintenance.

The owner obligations:

- ⊙ Ensure that the vehicle has scheduled servicing according to the service schedule;
- ⊙ Such servicing should be undertaken at an authorised UBCO technician;
- ⊙ The owner is responsible for the maintenance obligations and must drop off and pick up the vehicle, at their own cost, to an authorised UBCO technician.

Owner Operation Checks

We recommend a 24-month service schedule, **see page 74**. Request your UBCO certified technician fill in the relevant fields of the service logs, starting on page 76.

The 2X2 should be serviced at the indicated mileage or time, whichever occurs first. Once you have completed your 24 month service, we recommend you continue to get your 2X2 serviced every 6 months.

Insist on only genuine UBCO parts being installed in your 2X2 to ensure validity of the warranty.

Owner Maintenance

We have provided instructions for maintenance operations on the following pages. If you do not have the tools or competence to carry out the procedure, please take the bike to an UBCO authorised service technician. Do not attempt any maintenance that you are not familiar with.

Your Field Kit

Along with this manual, we've included a small Field Kit to get you through basic maintenance procedures. You may require more advanced tools, such as a torque wrench, to properly complete some tasks, but the kit will get you through in a pinch.

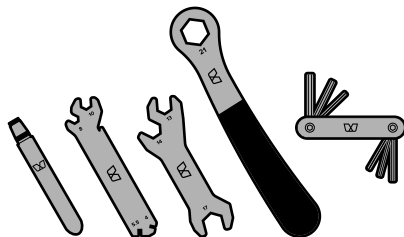

The Field Kit includes:

- ⊙ 8/10mm spanner with 4/5.5mm spoke wrench
- ⊙ 13/14/17mm spanner
- ⊙ 21mm spanner
- ⊙ Allen key multi-tool
- ⊙ Travel pen
- ⊙ Securing keys & key fobs

Replacing Key Fob Battery

Remove the silicone sleeve. Turn the key fob over so that the button faces down. Using your fingernail, separate the two halves of the key fob. Slide the battery out and replace with a new CR2032 battery, observing polarity. Position the rear plate over the base and push down to secure.

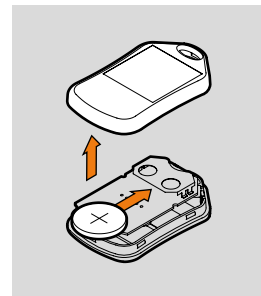

Wheels

The front and rear wheels are identical except for the inserts installed on the axles. This means either wheel can be installed at the front or rear as long as the correct inserts and torque arms are used. If you remove the wheels often, periodically apply a thread locker adhesive to the wheel nuts.

Tyre Pressure

The tyres on your 2X2 use a standard, car style valve for inflation and deflation. For standard riding, we recommend inflating the tyres to around 25 psi or as specified on the tyre.

Removing the Front Wheel:

- Unscrew the motor cable lock sleeves and detach the motor cable ends.
- With a No. 21 spanner, loosen the two serrated flange nuts.
- Remove the left and right torque arms from their recesses in the fork and remove the wheel.
- When putting the wheel back on, ensure the torque arms sit flush in their casing and the nuts are tightened to 90Nm with a torque wrench.

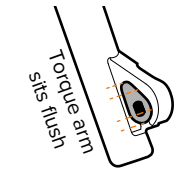
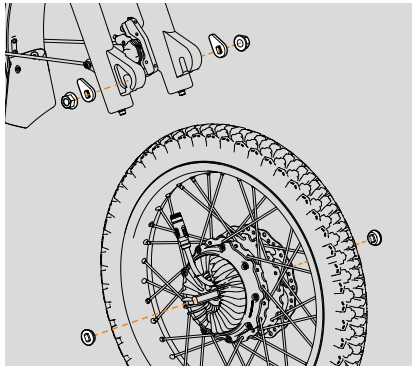

M14 SERATED FLANGE NUT



AXLE BUSH

Removing the Rear Wheel:

- Unscrew the motor cable lock sleeves and detach the motor cable ends.
- Using a 5mm Allen Key unscrew and remove the two M8 countersunk cap screws on the torque arms.
- With a No. 21 spanner, loosen and remove the two serrated flange nuts.
- Remove the left and right torque arms from the recesses in the swing arm and remove the wheel.
- When putting the wheel back on ensure that the nuts are tightened to 90Nm with a torque wrench.

Tool Tip: Add a medium strength thread lock to the nuts before fastening.

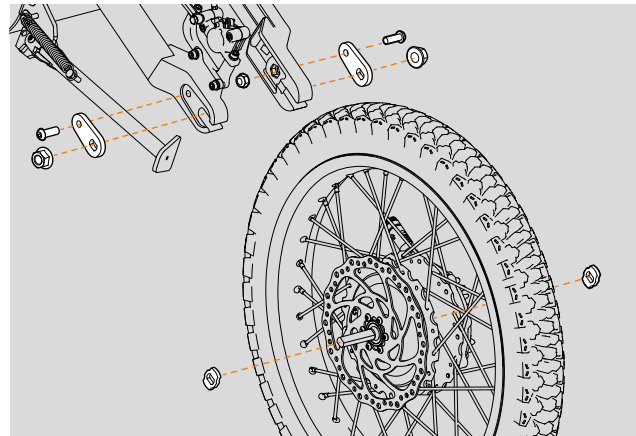

M8 x 25mm COUNTERSUNK



M14 SERATED FLANGE NUT



REAR TORQUE ARM



M8 NYLOC NUT



SPACER INSERT

Replacing Brake Pads

Ensuring your brake pads are in good condition is critical to your safety. Check the brake pads regularly, especially when a lot of heavy braking has occurred.

Replacement brake pads are available from UBCO Ltd or your UBCO dealer.

⚠ Brake rotors get hot during braking. Allow sufficient time for brakes to cool before touching or doing any maintenance.

To replace the brake pads:

- a. Unscrew the pin on the top of the calliper body with a number 3 Allen key, remove the end clip and pull the pin.
- b. Remove the brake pads from the top of the calliper and discard. Guide new brake pads in, from the top of the calliper, until the holes line up. Do not touch the pad surface with your skin.
- c. Re-install the fastening pin and tighten with the Allen key. Replace the end clip.

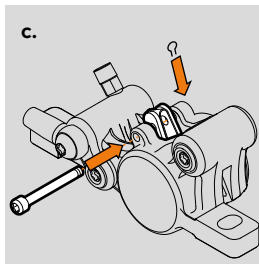
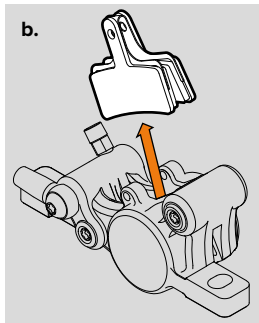
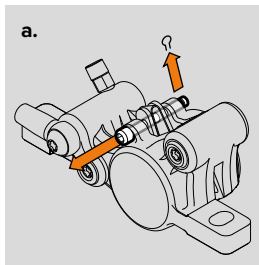

Bedding-in the Brakes

For optimum brake performance with new bikes and brake pads, we recommend doing a series of 10 sequential, firm braking efforts from 40kph to 5kph in a controlled environment. This will ensure that the brake pad material is sufficiently deposited onto the rotor, improving the total braking force available, as well as resistance to over-heating.

Cleaning the Bike

It's important to keep your 2X2 in a good working order so it's ready to go when you are. To ensure it's always in the best condition possible, you should clean your 2X2 regularly.

Incorrect cleaning methods can void your warranty, so take care and make sure you follow these points.

Do:

- ⊙ Clean your 2X2 after each day of use, especially when exposed to dirty terrain or salt water. If you are using the 2X2 in a clean environment, this may not be necessary.
- ⊙ Before cleaning, turn the 2X2 off. Ensure all power outlets, including the power supply, have their rubber seals securely in place. **The power supply should be plugged into the 2X2 while cleaning.**
- ⊙ Clean the 2X2 with a low pressure hose and soft automotive cleaning brush or sponge.

Do Not:

- ⊙ Do not water blast or use a high pressure hose on the 2X2.
- ⊙ Do not submerge electrical parts – they are protected from the rain and splashes, but should not be left in water.
- ⊙ Do not use cleaning products that are not specifically designed for cars or motorcycles. They may contain ingredients that could scratch the finish or harm components of the 2X2.

ANY QUESTIONS?

06 TROUBLESHOOTING

Got your gumboots stuck¹⁵ while you're out and about? Find the answer here or go online to ubco.com/pages/FAQ.

MEET THE LOCALS: Weta

Though it looks like a giant cricket, the weta are too heavy to fly and can outweigh a mouse. Weta comes from the Māori weta-punga, meaning “god of ugly things.”

Fossils found from the Triassic period 200 million years ago show striking similarities to the weta; today there are over 70 species in NZ.



We've collected together a few common problems that have a simple fix. If you suspect your bike may be damaged or is functioning improperly, contact UBCO or your technician for assistance.

My bike won't turn on.

- ⊗ Check that your 2X2 power supply is charged up.
- ⊗ Check that the battery in the key fob has a charge or put in a new CR2032 cell battery (see instructions page 53).
- ⊗ Check the power supply connection is clean & fully plugged in.

My bike is turned on but it won't go.

- ⊗ Check the kickstand is retracted.
- ⊗ Check the kill switch is disengaged.
- ⊗ Check the motor cables are properly connected.
- ⊗ Check the motor temperatures on the UBCO App. If they're over 125°C or 255°F, wait a few minutes for them to cool down before resuming your ride.
- ⊗ Check the UBCO App for any fault codes (see common codes on the following pages).

My bike is on and going but the lights aren't working.

- ⊗ Check your settings via the UBCO App. The LIGHTS setting allows the lights to be turned off or disconnected.

I can hear a rattling while I'm riding.

- ⊗ Ensure all load and attachments are secure.
- ⊗ Check the spoke tension and tighten if required.
- ⊗ Check all fasteners are tightened.
- ⊗ Check the brake rotors for dirt or debris.
- ⊗ If you're still hearing something strange, there could be a more serious problem. Get home and call us or your local dealer for assistance.

I can't reach my expected top speeds on flat ground.

- ⊗ If you've recently updated your UBCO App, make sure location services are turned on. The app is location sensitive and can drop the maximum speed limit incorrectly after an update if your location is turned off.
- ⊗ If the motors are overheating, they will reduce power. Check your UBCO App – if the motor temperature is over 95°C or 200°F, stop riding for a few minutes and allow them to cool.

The front wheel is losing traction uphill.

- ⊗ Unlike a gas-powered motorcycle, where you might lean back to give the rear wheel more traction, the 2X2 is powered by both wheels. When riding uphill, shift your weight forward to ensure the front wheel gains traction and can pull you up the hill.
- ⊗ Ensure your load is evenly distributed and not exceeding load limits detailed on page 46.

What if my charge runs out while I'm away from the charger?

- ⊗ Pay attention to your charge level while riding. If you're not sure that you'll have enough charge to make it home, reduce your power settings or switch the bike into Learner Mode using the UBCO App. This will lower your speed and reduce power consumption, which will extend your range.
- ⊗ Find a hill to ride down with the brakes on to regenerate power back into the power supply. That regenerated power could allow you to ride on flat sections again.

Fault Codes

If there is a problem with your 2X2, the warning light will illuminate in the top bar of the LCD display and a fault code will show in the odometer area. Fault codes can also be read using the UBCO App.

There are two types of codes:

- ⊙ **Cautions:** These codes will start with C-XXXX. These codes are labelled as cautions due to the fact they will not stop the bike from operating but still require attention, as the bike may no longer meet safety or compliance standards.
- ⊙ **Faults:** These codes will start with F-XXXX. These codes are labelled as faults because they relate to a specific fault on the bike that leads to the bike not operating correctly. They require immediate attention and may require servicing by an UBCO certified technician.

Examples:

C-1058

C = Caution

F-2056

F = Fault

If the first number in the code is 1, it relates to something in the front of the bike; if it is a 2 it relates to something in the rear.

Some common **Caution** codes are listed here. C faults indicate a warning that the bike is experiencing a problem but can still operate. If the fault persists follow the remedy indicated or contact your service provider.

Code	Fault; Possible Cause	Recommendation
C-0001, C-0002	Head/tail light open circuit; wiring or connector problem. Lamp failure. VMS failure.	Turn bike off then on, check connection, replace lamp.
C-0003	Indicator or brake light open circuit; wiring or connector problem. Lamp fail. VMS fail.	Turn bike off then on, check connection, replace lamp.
C-0004, C-0005	Only one indicator operational; wiring or connector problem. Lamp failure. VMS failure.	Turn bike off then on, check connection, replace lamp (04: left, 05: right).
C-0006	Indicator or brake light short circuit; wiring or connector problem. Lamp fail. VMS fail.	Turn bike off then on, check connection, replace lamp.
C-0007	Bluetooth initialisation failure; VMS failure	Turn bike off then on, try to update via App.
C-0010	Geofencing is actively reducing bike power/speed.	Get bike back to allowed geo area.
C-0011	Throttle too tight.	Check if throttle is stuck on. Rotate throttle forward.
C-1058, C-2058	Flat battery.	Check battery level, charge battery.
C-1061, C-2061	Over voltage, incorrect battery.	Check battery level. Should clear with use.
C-1062, C-2062	Motor over temp.	Allow the motors to cool down.
C-1063, C-2063	Controller over temp.	Allow controllers to cool. Check front panel is clear of mud, dust, etc.

Some common **Fault** codes are below. Codes beginning with F indicate a warning that the bike requires immediate attention. Follow the remedy indicated or contact your service provider.

Code	Fault; Possible Cause	Recommendation
F-0001	VMS application crash; electrical interference.	Turn bike off then on, update bike firmware.
F-1001, F-2001	Motor controller communication timeout; wiring problem between VMS and motor controller.	Turn bike off then on, update bike firmware.
F-0003	High ambient temperature, VMS over 100°C.	Allow bike to cool in shaded area.
F-1011, F-2011	Battery voltage is more than 60v.	Check battery level. Test/change battery charger – Always use UBCO recommended battery charger. Fit correct battery.
F-1015, F-2015	Controller over temperature.	Allow controllers to cool. Check front panel is clear of mud, dust, etc.
F-1016, F-2016	Hall sensor fault.	Check motor cable for damage or water ingress.
F-1017, F-2017	Input voltage low (controller under voltage).	Check battery level. Check connections to battery including clip.
F-1018, F-2018	Motor post static gating test.	Check motor cable.
F-1022, F-2022	Motor instantaneous phase over current from sudden shock to wheel.	Turn bike off then on.
F-1023, F-2023	Motor over temperature.	Allow motor to cool.

F-1024, F-2024	Throttle voltage outside range.	Check if throttle is stuck on. Check for wiring damage. Check throttle output voltage.
F-1028, F-2028	Instantaneous controller under voltage.	Check battery level. Check connections to battery.
F-1052, F-2052	Hall sensor signals not being received.	Check motor cable connections for water/damage.
F-1053, F-2053	Motor has exceeded its time for not rotating.	Motor has stalled. Check for obstruction and free wheel rotation.
F-1056, F-2056	Hall illegal sector; Wiring or connector problem. Motor failure.	Check motor cable connection for water/damage.
F-1057, F-2057	Hall illegal transition; Wiring or connector problem. Motor failure.	Check motor cable connection for water/damage.
F-1064, F-2064	Hall sensor signals not being received by VMS.	Check motor cable and connection for damage.

If the code is not listed here or the fault code persists, contact your service agent.

THE LAST BITS & PIECES

07 FINE PRINT

PHOTO CREDITS:

Kiwi – page 9 – Duncan Innes, Ngāi Tahu Tourism
Tane Mahuta – page 33 – Natalia Volna via Flickr
Tuatara – page 43 – CreativeNature_nl via iStock
Kea – page 51 – Pablo Heimplatz via Unsplash
Weta – page 59 – Tuan Nguyen via photonewzealand
Tui – page 67 – Jan Kaluza via Unsplash



MEET THE LOCALS: Tui

The most distinctive thing about a Tui, after the white tuft on its neck is the sound, both its loud wings and distinctive song. It has two voice boxes and can produce notes so high that they are not audible to the human ear. It also whistles, groans, crackles, creaks, chuckles, chortles and wheezes and have been known to mimic human speech.

Vehicle Compliance

The UBCO 2X2 is a type rated vehicle designed for one rider only. It complies with the following country vehicle regulations:

- ⊙ **Australia:** LA Class (Moped). This vehicle was manufactured to comply with the Australian Motor Vehicle Safety Standards Act 1989.
- ⊙ **New Zealand:** LA Class (Moped). This vehicle was manufactured to comply with the Australian Motor Vehicle Safety Standards Act 1989, which is accepted in New Zealand.
- ⊙ **United States:** This vehicle conforms to all applicable Federal Motor Vehicle Safety Standards (FMVSS) in effect on the date of manufacture. This is classified as a 'Motorcycle' with a 'Motor Driven Cycle' exception being under 5 BHP and having a maximum obtainable speed of 30mph.
- ⊙ **UK/Europe:** L1e-B vehicle class. The vehicle was designed and manufactured to comply with the directives and regulations in effect on the date of manufacture for this vehicle class.

FCC Compliance

This equipment has been tested and found to comply with the limits for a Class B digital device, pursuant to part 15 of the FCC Rules. These limits are designed to provide reasonable protection against harmful interference in a residential installation. This equipment generates, uses and can radiate radio frequency energy and if not installed and used in accordance with the instructions, may cause harmful interference to radio communications. However, there is no guarantee that interference will not occur in a particular installation. If this equipment does cause harmful interference to radio or television reception, which can be determined by turning the equipment off and on, the user is encouraged to try to correct the interference by one or more of the following measures:

- ⊙ Reorient or relocate the receiving antenna.
- ⊙ Increase the separation between the equipment and receiver.
- ⊙ Connect the equipment into an outlet on a circuit different from that to which the receiver is connected.
- ⊙ Consult your UBCO technician or an experienced radio/TV technician for help.

Limited Warranty

UBCO warrants to the original purchaser that the Products shall be free, under normal use and maintenance, from any defects in material or workmanship for the warranty periods set out on our website (www.ubco.com/) subject to the qualifications, exclusions, conditions, and limitations set out in this warranty statement. Where warranty conditions are met, defective Products or parts will be repaired or replaced (repair or replacement is at UBCO Limited's discretion).

Qualification of 2X2 Bike Warranty

If the 2X2 Bike was purchased from an authorised UBCO dealer or via Click & Collect on the UBCO website, the dealer must remove the bike from its original packaging, complete the Pre-Delivery Inspection (PDI) and the final bike set-up following instructions provided by UBCO. They must also test ride the bike before final hand over to the purchaser. The Registration Form (page 2) must be signed by the dealer and the purchaser and must specify who assembled and set up the bike. The online registration process via www.ubco.com/register/ must also be completed by either the purchaser or dealer.

If the 2X2 Bike was purchased and shipped directly to the purchaser from UBCO, the Pre Delivery Inspection will have already been completed by UBCO before shipment and the following steps must be taken by the purchaser.

1. Enrol in and complete the "Your 2X2 Bike Set Up" course on UBCO University (www.ubcouniversity.com).

2. Remove the bike from its original packaging and complete the final set-up following the instructions provided on the poster included with the bike and/or online via UBCO University in step 1.
3. Complete the Online Registration Form at www.ubco.com/register/ and also fill in the Registration Form at the front of this manual (page 2).

General Exclusions

This warranty does not cover:

1. Products used other than in accordance with their intended use or the instructions/parameters set out in this User Manual;
2. Products that have been misused, involved in an accident, neglected or abused;
3. Products used for competition including but not limited to racing or trials;
4. Products used for rentals or any commercial application, other than those for which the Product is intended and which have been specifically approved by UBCO;
5. Products that have been improperly assembled, or where repairs have been made other than by an UBCO certified technician;
6. Products that have not been maintained or serviced in accordance with the instructions set out in this User Manual;
7. Products altered or modified in any way from the manufacturer's specifications;
8. Parts requiring replacement or repair as a result of normal wear and tear.

Specific Category Exclusion

2X2 Warranty Exclusions:

- ⊙ The planetary gears are considered a wear and tear item and should be regularly inspected and replaced in the event of wear. Wear is related to the level and type of use. Planetary gears and elements of the motor system are designed to protect the main motor. In extreme stress, they may be damaged in order to protect the motor's integrity;
- ⊙ If motor maintenance or repair is performed by a non-UBCO Certified Technician, including if the motor is opened or modified;
- ⊙ If any of the control system parameters are modified from those issued by UBCO for public release;
- ⊙ If water damage occurs as a result of a 2X2 being used outside of its intended operation and use. Damage includes, but is not limited to; the following component groups: the external controls, electrical system, motors, power supply connections and bearings;
- ⊙ If damage is caused by over-torquing, cross threading, or other damage due to attempted repair by unauthorised service personnel.

Power Supply Exclusions:

- ⊙ If the power supply is left in a discharged state;
- ⊙ If the plug connectors (male and female) have not been cleaned and are exposed to dirt, water and other environmental contaminants;
- ⊙ If the case has been opened or tampered with;
- ⊙ If there has been damage caused to the external case or structure e.g. from dropping or accidents;
- ⊙ If used with non-approved or uncertified electrical equipment;
- ⊙ If the product has been submerged under water.

Consumer Law

New Zealand: The Consumer Guarantees Act 1993 may apply to the transaction covered by this warranty. In the event that the Act applies, this warranty is to be considered as an express guarantee for the purposes of the Act. Where the terms of the warranty and the provisions of the Act conflict, the provisions of the Act will prevail.

The general exclusion, Limitations and Specific Category exclusions that are contained in this warranty do not in any way restrict or limit any liability that UBCO Limited may have under the Act. However, this warranty and any resultant express guarantee will be subject to the qualifications and limitations of the Act.

This warranty in no way limits or affects UBCO Limited's obligations to comply with section 6, 9 or 12 the Act.

Australia: Our goods come with guarantees that cannot be excluded under the Australian Consumer Law. You are entitled to a replacement or refund for a major failure and compensation for any other reasonably foreseeable loss or damage. You are also entitled to have the goods repaired or replaced if the goods fail to be of acceptable quality and the failure does not amount to a major failure.

In the event that the Competition and Consumer Act 2010 applies, this warranty is to be considered as an express guarantee for the purposes of the Act. Where the terms of the warranty and the provisions of the Act conflict, the provisions of the Act will prevail.

United States: All other conditions or warranties, which might otherwise be implied by statute or common law, are expressly excluded to the maximum extent permitted by law.

European Union: Our goods come with guarantees that cannot be excluded under each national legal act (of each member state) which implements the guarantees specified in the Consumer Rights Directive 2011/83/EU. You are entitled to a replacement or refund for a major failure and compensation for any other reasonably foreseeable loss or damage. You are also entitled to have the goods repaired or replaced if the goods fail to be of acceptable quality and the failure does not amount to a major failure. Please also be aware that your rights in terms of goods guarantees are limited to only those specified in the above-mentioned national legal act and nothing else is contractually implied.

The expiration term of these rights shall coincide with the term specified in each national legal act (of each member state). Where the terms of the warranty and the provisions of the national legal act conflict, the provisions of the national legal act will prevail.

United Kingdom: Our goods come with guarantees that cannot be excluded under the Consumer Rights Act 2015. You are entitled to a replacement or refund for a major failure and compensation for any other reasonably foreseeable loss or damage. You are also entitled to have the goods repaired or replaced if the goods fail to be of acceptable quality and the failure does not amount to a major failure. Please also be aware that your rights in terms of goods guarantees are limited to only those specified in the above-mentioned national legal act and nothing else is contractually implied.

For goods purchased in England or Wales, these rights expire six years from delivery of the goods and for goods purchased in Scotland, these rights expire five years from delivery of the goods. Where the terms of the warranty and the provisions of the Act conflict, the provisions of the Act will prevail.

Maximum Liability

To the maximum extent permitted by law, UBCO's maximum liability in contract, tort, equity, statute, regulation or otherwise for any loss, damage, or injury directly or indirectly resulting from any defect in, or non-compliance of, or use of, the Product will not in aggregate exceed the price (excluding GST) for the Product that caused the loss, damage or injury.

Owner's Obligations

Where a User Manual is supplied with a Product, the purchaser of the Product and ultimate end user must review the Manual to understand the operations, limitations, maintenance and care instructions for the Product.

Whilst UEV and Portable Power Supplies have fewer moving parts than a combustion engine vehicle or technology they still require maintenance to ensure continued safe operation. Every Product will need scheduled maintenance and care, to ensure your warranty is maintained. This will increase the Product's lifespan and reduce life time maintenance.

UBCO Authorised Dealers and Certified Technicians

For a list of UBCO Authorised Dealers and Certified Technicians, please see our website www.ubco.com.

Servicing Schedules

Regular servicing should only be carried out by an UBCO certified technician or dealer. Look on the UBCO website to find the dealer nearest you.

In addition to this, after the first 10 hours of riding you should get an initial, complementary check over your bike from your dealer.

Standard Users

The 2X2 should be serviced at the indicated mileage or time, whichever occurs first:

- ⊙ Complimentary Check
After first 10 hours of riding
- ⊙ First Maintenance Service
2,000km / 1,242mi / 10 weeks
- ⊙ Second Maintenance Service
4,000km / 2,485mi / 6 months
- ⊙ Third Maintenance Service
8,000km / 4,970mi / 12 months
- ⊙ Fourth Maintenance Service
12,000km / 7,456mi / 18 months
- ⊙ Fifth Maintenance Service
16,000km / 9,941mi / 24 months

Once you have completed your 24 month service, we recommend you continue to get your 2X2 serviced every six months.

Farming Users

Farming conditions require a more robust maintenance schedule so the following schedule should be used.

- ⊙ First Maintenance Service (Complimentary)
200km / 125mi / 10hrs / 1 month
- ⊙ Second Maintenance Service
1,500km / 932mi / 100hrs / 4 months
- ⊙ Third Maintenance Service
3,000km / 1,864mi / 200hrs / 7 months
- ⊙ Fourth Maintenance Service
4,500km / 2,796mi / 300hrs / 10 months
- ⊙ Fifth Maintenance Service
6,000km / 3,728mi / 400hrs / 13 months
- ⊙ Sixth Maintenance Service
7,500km / 4,660mi / 500hrs / 16 months
- ⊙ Seventh Maintenance Service
9,000km / 5,592mi / 600hrs / 19 months
- ⊙ Eighth Maintenance Service
10,500km / 6,524mi / 700hrs / 22 months
- ⊙ Ninth Maintenance Service
12,000km / 7,456mi / 800hrs / 25 months

Once you have completed your 25 month service, we recommend you continue to get your 2X2 serviced every three months. For specific service requirements tailored to your situation, please contact your service technician.

Service Log

Initial 10hr Check

Complete

Date serviced:

Odometer:

Hourmeter:

Technician:.....

Signed:.....

Second Service

Complete

Date serviced:

Odometer:

Hourmeter:

Technician:.....

Signed:.....

Fourth Service

Complete

Date serviced:

Odometer:

Hourmeter:

Technician:.....

Signed:.....

First Service

Complete

Date serviced:

Odometer:

Hourmeter:

Technician:.....

Signed:.....

Third Service

Complete

Date serviced:

Odometer:

Hourmeter:

Technician:.....

Signed:.....

Fifth Service

Complete

Date serviced:

Odometer:

Hourmeter:

Technician:.....

Signed:.....

Sixth Service

Complete

Date serviced:

Odometer:

Hourmeter:

Technician:.....

Signed:.....

Eighth Service

Complete

Date serviced:

Odometer:

Hourmeter:

Technician:.....

Signed:.....

Additional Service

Complete

Date serviced:

Odometer:

Hourmeter:

Technician:.....

Signed:.....

Seventh Service

Complete

Date serviced:

Odometer:

Hourmeter:

Technician:.....

Signed:.....

Ninth Service

Complete

Date serviced:

Odometer:

Hourmeter:

Technician:.....

Signed:.....

Additional Service

Complete

Date serviced:

Odometer:

Hourmeter:

Technician:.....

Signed:.....

Additional Service

Complete

Date serviced:

Odometer:

Hourmeter:

Technician:.....

Signed:.....

Additional Service

Complete

Date serviced:

Odometer:

Hourmeter:

Technician:.....

Signed:.....

Additional Service

Complete

Date serviced:

Odometer:

Hourmeter:

Technician:.....

Signed:.....

Additional Service

Complete

Date serviced:

Odometer:

Hourmeter:

Technician:.....

Signed:.....

Additional Service

Complete

Date serviced:

Odometer:

Hourmeter:

Technician:.....

Signed:.....

Additional Service

Complete

Date serviced:

Odometer:

Hourmeter:

Technician:.....

Signed:.....

NOTES:

Grid of dotted lines for notes.