

Large Square Balers

LSB Series



www.kuhn.com



be strong, be **KUHN**



LSB

Series

KUHN LARGE SQUARE BALERS

ULTIMATE FIELD PERFORMANCE, MAXIMUM OUTPUT



CAPACITY

Our goal is to develop machines that will give a boost to the profitability of your company. High output is a key success factor for every large square baler. KUHN large square balers feature several unique points that will provide the capacity your company requires.

SQUARE BALES

Perfectly shaped, consistently square bales are the end-result every customer is looking for. With over 30 years of experience in large square baling, our machines can produce rock-hard bales.

RELIABILITY

To achieve maximum efficiency from your machine, unrivalled reliability is a must. The KUHN large square balers are designed with simple, but efficient techniques. The result is a minimum downtime machine in which you can truly trust.

LSB 870

3 x 2

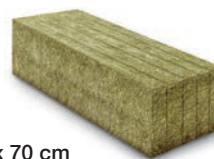

80 x 70 cm

LSB 890 D

3 x 3



80 x 90 cm

LSB 1270

4 x 2



120 x 70 cm

LSB 1270 DX

4 x 2

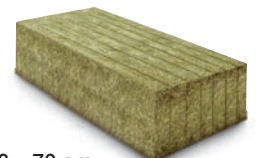

120 x 70 cm

LSB 1290 D

4 x 3



120 x 90 cm



CONSISTENT BALE SHAPE

THE IMPORTANCE OF BALE SHAPE

Consistently shaped bales bring more than just aesthetic appeal. A consistently filled bale represents quality in every form. Square bales are easy to stack and handle. In addition, they are much more stable during transport than a poorly formed bale. With silage, a perfectly square bale indicates less air content, resulting in high quality feed!

POWER DENSITY – THE KUHN SOLUTION

The complete mechanical POWER DENSITY system has proven its worth on all KUHN LSB balers. The system ensures consistently-filled flakes and rock-hard bales regardless of the condition of the windrow.

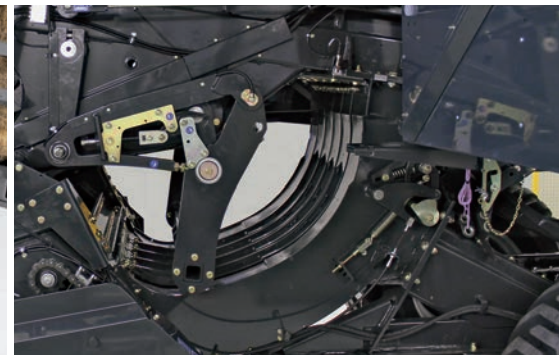
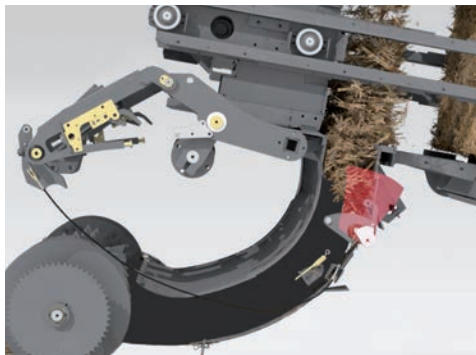

POWER DENSITY pre-chamber

The continuously rotating feeder fork combines two functions into one mechanism thereby eliminating the need for complex drivelines.





HOW DOES IT WORK?

The INTEGRAL ROTOR actively delivers the crop to the pre-chamber throughout which, in the initial phase, it is evenly distributed by the feeder fork. Regardless of the swath form, the POWER DENSITY system guarantees a perfectly filled pre-chamber.



The measuring wedges are positioned at the top of the pre-chamber (red). When these measure the correct density, the filling stroke is activated and the feeder fork is used to empty the pre-chamber and fill the bale chamber.

COMFORT AND QUALITY

A unique feature is the inspection hatch in the bottom of the pre-chamber. For easy access to the pre-chamber the complete under-side can be opened without using

To further improve machine performance in wetter crops, an easy flow kit can be fitted to the pre-chamber. The Teflon plates result in a perfect crop flow in wet, sticky material. tools.

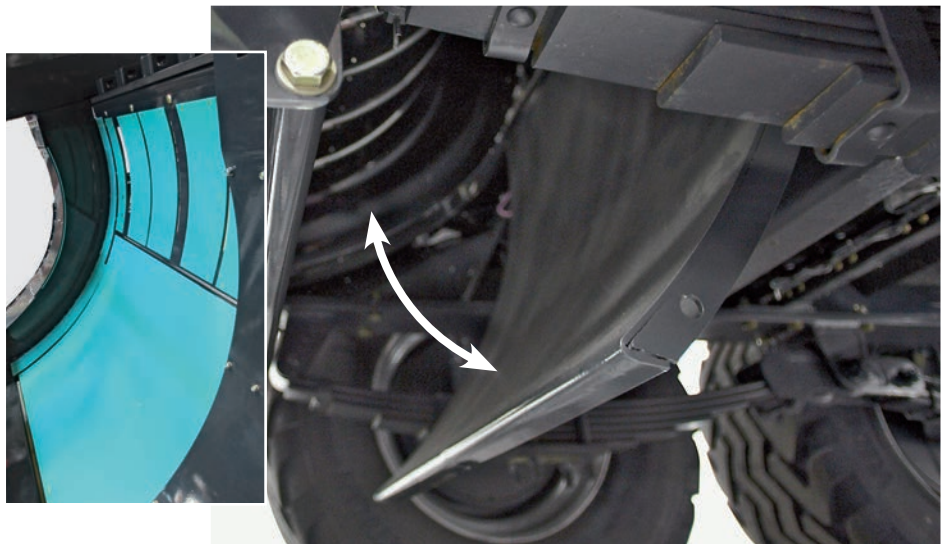

Pre-chamber inspection door





IT ALL STARTS WITH THE INTAKE

The pick-up of the KUHN LSB is designed to match the full capacity of the machine. With an intake width of 230 cm, the machine is capable of working in all swaths. The reliable cam track system will not let you down, even in the harshest conditions. To adapt the machine to your purposes, you have the choice between fixed and pivoting pick-up wheels.

MORE CAPACITY

Optional on the LSB models is a driven crop roller. With the driven crop roller, the machine can reach up to 15% higher capacity in dry bulky swaths. For optimal performance, the crop roller is mechanically driven and protected by a cam clutch.

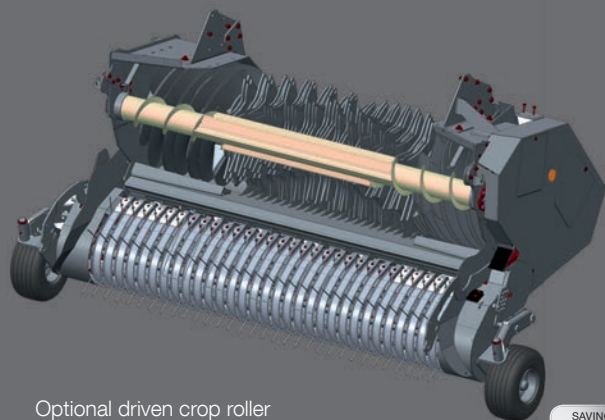

Optional driven crop roller

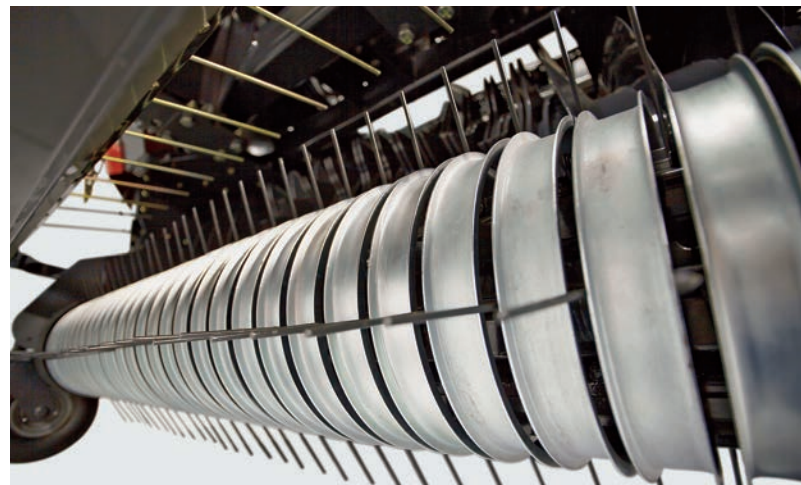

INTEGRAL ROTOR CROP FLOW ALWAYS CONTROLLED

All KUHN LSB balers, cutting or non-cutting versions are equipped with the INTEGRAL ROTOR. This simple, maintenance free intake system ensures even feeding regardless of the various (crop) conditions. The short distance between rotor and pick-up yields an outstanding crop flow. This force-fed intake makes higher forward speeds possible for outstanding productivity and reduced crop damage.

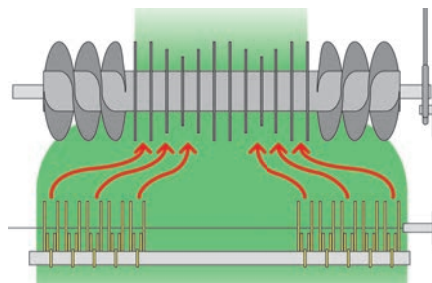



OPTIFEED - NON CUTTING VERSION

When crop cutting is not required, the OPTIFEED system ensures a controlled and consistent crop flow to the pre-chamber. With the rotor, an additional level of protection is added to the machine.

OC - CUTTING VERSIONS

The OC cutting systems are designed for unlimited intake capacity. There are two different types of KUHN OC cutting system (availability dependent on LSB model):

- OC 15

The OC 15 offers a cutting length of 45 mm. The KUHN patented rotor tine shape ensures a low power requirement and a perfect cutting quality. The knives, individually protected with a spring, can be changed easily with the standard cassette system.

- OC 23

The OC 23 offers a cutting length of 45 mm on the 120 cm wide machine. With a rotor diameter of 60 cm, the OMNICUT rotor will process every swath that is placed in front of the baler. The knives on the OC 23 have individual hydraulic protection. This ensures a perfect cutting quality regardless of working speed and crop.

With just two levers the operator can easily choose from the following knife group configurations: 0 – 11 – 12 – 23. Together with the standard cassette system for easy knife changing, you not only invest in cutting quality but, above all, in driver comfort.



Knife cassette system



Knife selection

INTEGRAL ROTOR Type	LSB 870	LSB 890 D	LSB 1270	LSB 1270 DX	LSB 1290 D
OPTIFEED - Without cutting device	X	X	X	X	X
OC -15 - 45 mm cutting length, cassette	X	X			
OC -23 - 45 mm cutting length, cassette			X	X	X

*patent or patent pending in one or more countries



THE BALE CHAMBER

The specially designed bale chamber of the KUHN LSB machines is the result of more than 30 years' experience in big square baling. With the 3 meter long bale chamber, there is plenty of space to form a perfect bale. The combination of aggressive retainers and pressure door shape brings an aggressive compaction and gentle expansion of the bale.



PLUNGER

The 46 plunger strokes per minute result in a high compaction capacity. The plunger is guided via 4 large rollers with a diameter of 125 mm for maximum service life.

XTRA BALE DENSITY

The LSB 1270 DX can reach up to 10% more density compared to previous models. The DX offers several additional features to help increase density:

- Xtra strong main gearbox
- Xtra strong main frame and bale channel design
- Xtra dimension of bale channel cylinders



3 m (9' 10") bale chamber, with last bale ejection



Bottom retainers prevent decompression of the bale and provide extra density



DENSITY REGULATION

KUHN LSB balers are known for their perfectly shaped bales with consistent density. The density can be regulated in two ways according to the driver's preference. Using the conventional setting, the density is directly regulated from the terminal. With the automatic setting, the machine detects the load and automatically adjusts the pressure on the bale channel. Switching between the two settings is quick and easy resulting in a versatile, easy to operate machine.

MOISTURE

To give you the best possible information about your crop and your machine, the LSB baler can be equipped with a moisture sensor. This option gives you a good indication of the current crop moisture level.

LAST BALE EJECTOR

To guarantee safe transport on the road, the last bale ejector is used to remove the last bale from the chamber.



Moisture sensor

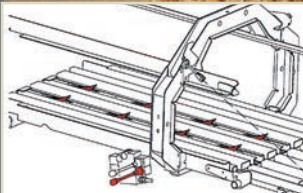

Last bale ejector



ROBUST DRIVELINE AND MAXIMUM SECURITY



Synchronized drive of components is made via gears and shafts. This ensures a perfectly synchronized machine with easy maintenance.

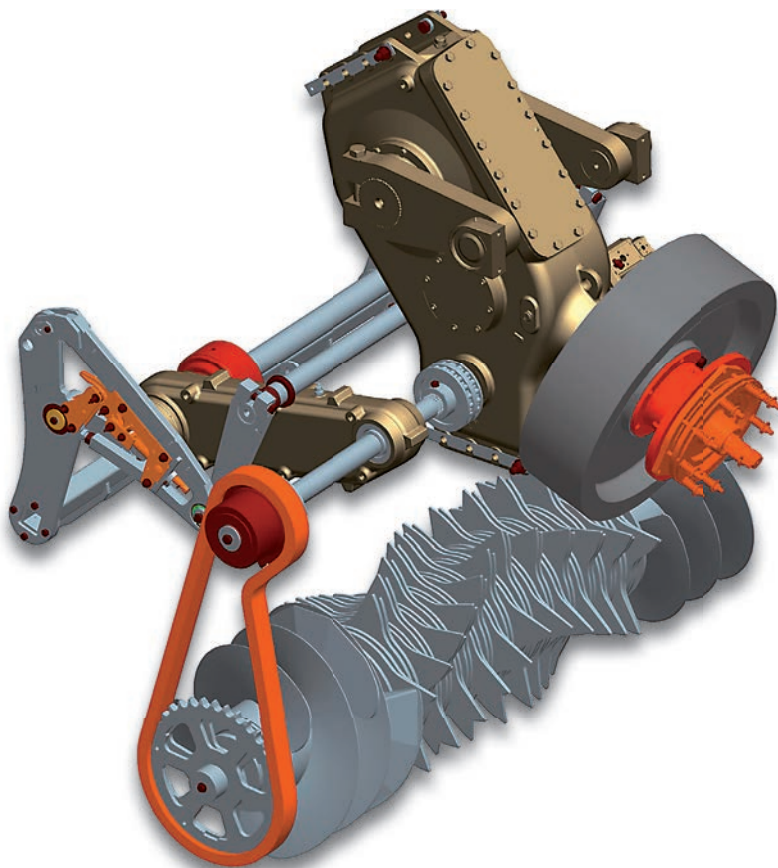

INSTANT PROTECTION

To use the machine at maximum capacity, a flawless protection system is required. All main intake components of the KUHN LSB balers are fitted with a cam type clutch. With this non-stop safety system you can unblock the machine from the operator seat.

The pickup, INTEGRAL ROTOR and feeder fork are protected with cam-type torque limiters, which are automatically activated in the event of an overload. The respective cam clutch then activates and the intake is stopped. The clutch re-engages when the operator reduces the PTO speed.

Another benefit of these clutches is that they give the ability to drive at a constant speed without worrying about blockages.



INTEGRAL ROTOR protection clutch



KNOTTING

A SOLUTION FOR EVERYBODY

One of the last steps in creating a perfect bale is the knot. With the knotting options on your KUHN LSB you can be sure of a reliable and secure knotting system that meets your requirements.



TWIN STEP KNOTTING

The unique TWIN STEP knotting system comprises a single knotter and smart system that releases the twine tension during the knotting cycle. The result is a secure, easy to adjust knotting system.

While baling, the knotters (blue) are at rest and the twine is guided by the twine tension release lever (red), in the vertical position. Tension is held on the twine to ensure maximum density in the bale.

Step 1: As the bale reaches the desired length, the needles (grey) are activated and move upwards towards the knotters to start the knotting cycle.

Step 2: By pivoting backwards the tension lever (red) releases the twine and consequently reduces tension to the knotter during the knotting cycle. This guarantees a perfect knotting process.

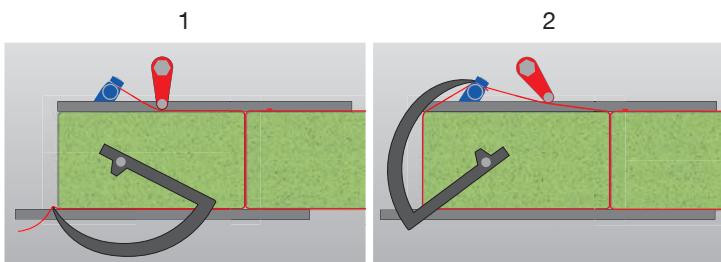

DOUBLE KNOTTING

The LSB D models are equipped with a double knotting system. With the electronic knotter control, the driver has accurate information concerning twine tension at all times and receives an alarm in case of risk. The knotting progress can be monitored directly from the tractor cab.

During baling, an upper (blue) and lower (red) twine is fed to the bale, because the twine is not slipping around the bale there is no tension on the twine during the bale formation.

Step 1: As the bale reaches the desired length, the needles (grey) are activated and move upwards to the knotter to start the knotting cycle. In this first step the bale is finished with the first knot.

Step 2: Once the first knot has finished the bale, the second knot connects the upper and lower twine again so the bale can be formed without stress on the twine during knotting.

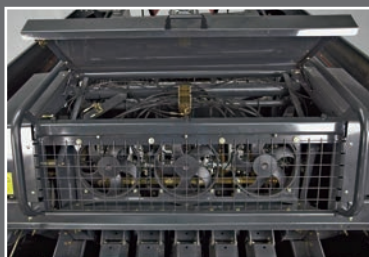
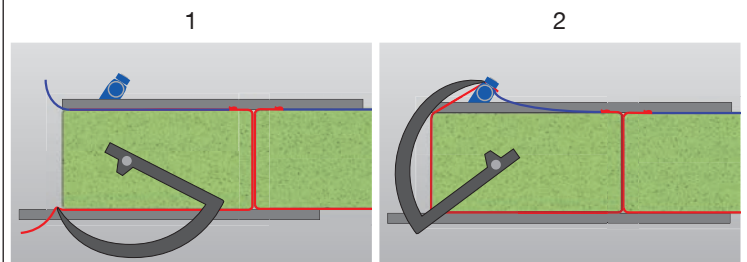

TWIN STEP models
Electric knotter fans

KNOTTER CLEANING

Double knotter models
Hydraulic driven fans

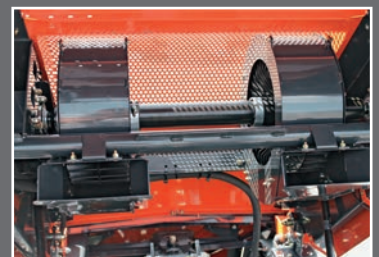



MAINTENANCE AND ACCESSABILITY

The KUHN LSB is designed to facilitate easy daily maintenance.



TWINE BOXES

The twine boxes swing out completely for easy access to the vital parts of the machine. Behind the full-access side doors, spools of twine can be stored. The twine storage itself is enclosed to prevent twine rolls from being contaminated with detritus, which could cause mis-ties. To reduce daily maintenance and to preserve your machine, the automatic central greasing system is fitted on most models.

The twine boxes on the single knotter models are capable of storing up to 24 twine spools. An extra option is a moveable service light. It can be plugged in at 3 convenient places and provide you with light where you need it.

The LSB double knotter models have a twine capacity of 30 x 13 kg spools and integrated dust protection through shielding of the twine boxes. The double knotter models are equipped as standard with 4 LED service lights to inspect your machine. As an option, there is a choice of 3 additional LED work lights to have a clear view all night long.



Automatic greasing system



Shielding and twine boxes

STORAGE HOSES

For clean & tidy storage, the LSB is equipped with a convenient storage place for the hoses and cables needed to operate the machine.



LED work lights



LED service lights



ELECTRONICS ALWAYS IN CONTROL



ISOBUS

All KUHN LSB balers are ISOBUS compatible. ISOBUS compatible tractors will therefore not require a separate control box for the baler. Alternatively, the VT 50 or CCI monitor can be used with tractors that are not ISOBUS compatible. Operator settings such as bale density and knife activation are accessed via the terminal. Operator warnings as overload, twine routing and operator information, including flakes per bale and number of bales are also provided.

VT 50

The KUHN ISOBUS VT 50 terminal has a 14,5 cm (5.7") color screen with outstanding clarity. Adjustments can easily be done by the touch screen and the large soft-touch keys on the sides. The VT 50 terminal can be used for all KUHN ISOBUS machines.

CCI 200

The ISOBUS compatible CCI 200 terminal has a large 21.6 cm (8.5") colour screen with outstanding clarity. Machine adjustments can be easily made via the touch screen or with the intuitive, large soft keys. The CCI 200 terminal can also be used with many other ISOBUS compatible machines on the market.

FULL VISIBILITY

To provide optimal visibility and safety around the machine, the LSB can be equipped with a KUHN group camera system. There are 2 versions available; one version is compatible with the CCI terminal, the other comprises a separate monitor and a camera.





BOOST YOUR PRODUCTIVITY WITH THE KUHN INTEGRATED BALE WEIGHING SYSTEM

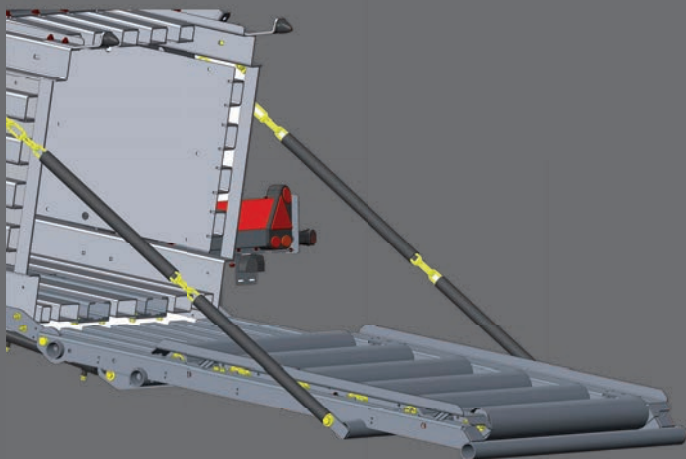

Integrated bale weighing system

The KUHN integrated bale weighing system is available for both 80 cm width balers and 120 cm width balers. Use of the KUHN integrated bale weighing system provides on the go feedback about the bale weight plus direct insight in your crop yield. With this information, you will have the possibility to organize your transport chain as efficient as possible. This will boost the productivity and profitability of your baling operation.

You have several options to display the bale weight in the cabin, also with integration in the standard field counter. This enables you to save all relevant information about your customer and field data on your terminal.

KUHN PARTS

DESIGNED AND MANUFACTURED TO RIVAL TIME



KUHN foundries and forge as well as a high-level manufacturing process allow the production of spare parts to defy time. You can truly rely on our know-how and our genuine parts. Farmers benefit from our client support and logistics services via any KUHN PARTS warehouse, which provide quick and reliable repair solutions in cooperation with your nearest authorized KUHN dealer.



be strong, be **KUHN**



PRE-CHOPPING AT ITS FINEST WITH THE KUHN CBB 200

Providing high quality forage, bedding and feeding is one of the main development goals for KUHN machinery. The CBB 200 pre-chopper has a specific design that matches the capacity and machine characteristics of the LSB baler range. With this combination, you will be able to produce an even higher quality baled product.

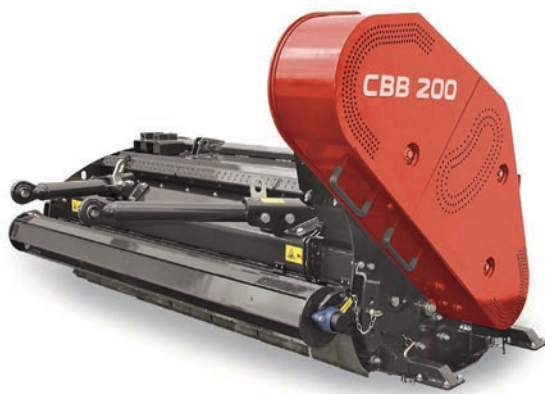

SMOOTH AND SHORT

With the industry leading 670 mm rotor, the CBB ensures a smooth running of the machine and a low power requirement. To ensure a perfect cut, and an aggressive damaging of the stem, the machine is equipped with 48 cutting blades and 2 counter knife banks giving a total of 98 counter knives. This results in a theoretical cutting length of 19.5 mm.

MAXIMUM VERSATILITY

The working height of the CBB offers a wide range of adjustment over for maximum adaptation to the given conditions and circumstances. With a ground clearance of 65 cm, the CBB 200 can remain on the machine when pre-chopping is not required. The drawbar is specially designed to match both the CBB 200 and the LSB balers, creating harmony between the two machines.

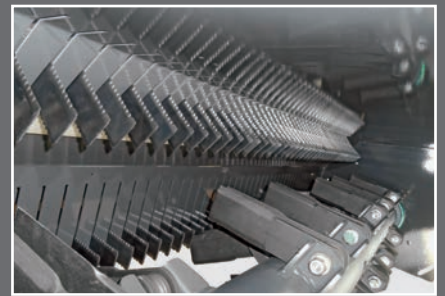



ALL YEAR LONG

To increase the profitability of your baling business, the KUHN LSB can be combined with equipment to extend your baling season. Solutions offered from within the KUHN group, or from external suppliers.



BIOMASS HARVESTING

In combination with the KUHN front mounted shredders as the WS 320 BIO, your LSB will become an efficient biomass harvesting machine suited for a broad range of crops.



TRACK AND TRACE – ADDING VALUE

KUHN LSB balers can be combined with Harvesttec equipment for big balers. If you require an preservative applicator, dye spray marker or bale tagging system, please contact your local KUHN dealer or KUHN representative in your country.



Preservative applicator



Bale tagging system



Dye spray marker

Specifications

	Balers with 80 crop flow channel				Balers with 120 crop flow channel					
	LSB 870	LSB 870 OC	LSB 890 D	LSB 890 D OC	LSB 1270	LSB 1270 OC	LSB 1270 DX	LSB 1270 DX OC	LSB 1290 D	LSB 1290 D OC
Bale dimensions	2x3		3x3		2x4		2x4		3x4	
Width	80 cm (32")		80 cm (32")		120 cm (47")		120 cm (47")		120 cm (47")	
Height	70 cm (28")		90 cm (35")		70 cm (28")		70 cm (28")		90 cm (35")	
Length	60 cm (24") up to 300 cm (118")									
Pick-Up										
Intake width	230 cm (91")									
Pick-Up diameter	34 cm (13")									
Number of tine bars	5									
Tine spacing	61 mm (2.4")									
Bale chamber										
Number of plunger strokes	46 / min									
Plunger stroke length	695 mm (27")									
Density control	3 hydraulic cylinders				4 hydraulic cylinders					
Bale chamber length	300 cm (9' 10")									
Controls	ISOBUS (VT50 / CCI200)									
Knotters										
Number of knotters	4				6					
Knotting system	TWINSTEP (optional)		Double knotter		TWINSTEP (optional)		Double knotter		Double knotter	
Knotting cleaning	Electric fans		Blowers		Electric fans - optional blower		Blowers		Blowers	
Twine spool capacity	24		30		24		30		30	
Intake system										
INTEGRAL ROTOR	OPTIFEED	OPTICUT	OPTIFEED	OPTICUT	OPTIFEED	OMNICUT	OPTIFEED	OMNICUT	OPTIFEED	OMNICUT
Knives	-	0/15	-	0/15	-	0/11/12/23	-	0/11/12/23	-	0/11/12/23
Theoretical cutting length	-	45 mm (1¾")	-	45 mm (1¾")	-	45 mm (1¾")	-	45 mm (1¾")	-	45 mm (1¾")
Knives protection	-	Individual spring	-	Individual spring	-	Individual hydraulic	-	Individual hydraulic	-	Individual hydraulic
Wheels and Axles*										
Single axle	Hydraulic or pneumatic brakes									
600/55-22.5	x	x	x	x	x	x	x	x	x	x
710/40R22.5	x	x	x	x	x	x	x	x	x	x
Tandem axle	Standard steering and suspension, hydraulic or pneumatic brakes									
500/55-20	x	x	x	x	x	x	x	x	x	x
560/45R22.5	x	x	x	x	x	x	x	x	x	x
620/50R22.5	x	x	x	x	x	x	x	x	x	x
Dimensions										
Length	780 cm (25'7")		800 cm (26'3")		800 cm (26'3")		800 cm (26'3")		800 cm (26'3")	
Width**	276 cm (9'1")		276 cm (9'1")		300 cm (9'10")		300 cm (9'10")		300 cm (9'10")	
Height	270 cm (8'10")		326 cm (10'7")		275 cm (9')		326 cm (10'7")		326 cm (10'7")	
Weight**	7900 kg (17415 lbs)	8200 kg (18075 lbs)	8600 kg (18960 lbs)	8900 kg (19620 lbs)	8800 kg (19400 lbs)	9450 kg (20830 lbs)	9290 kg (20481 lbs)	9940 kg (21914 lbs)	9700 kg (21385 lbs)	10350 kg (22815 lbs)
Minimum tractor requirement	66 kW (90 hp)	74 kW (100 hp)	77 kW (105 hp)	88 kW (120 hp)	81 kW (110 hp)	99 kW (135 hp)	96 kW (130 hp)	114 kW (155 hp)	103 kW (140 hp)	121 kW (165 hp)

Power requirement may vary with different crops, conditions and options used. Consult operators manual for proper tractor sizing.
* Depending on local homologation ** Depending on version and additional options

OVERVIEW

MACHINE HIGHLIGHTS

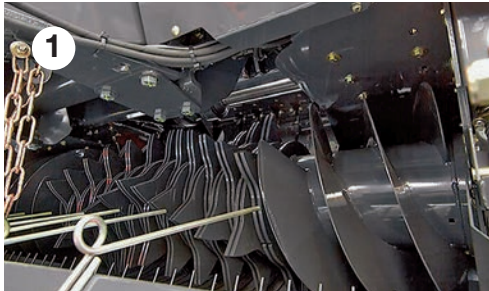

1 INTEGRAL ROTOR Technology

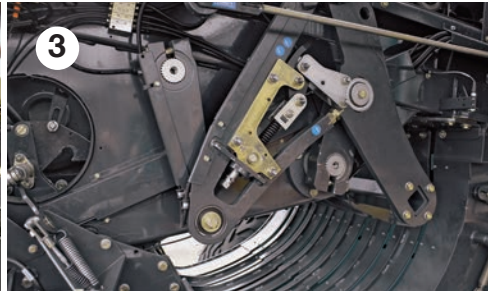

3 POWER DENSITY pre-chamber

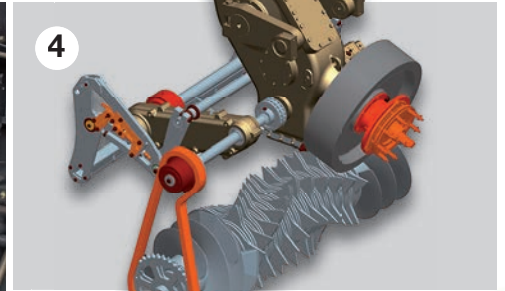

4 Cam clutch protection of intake components

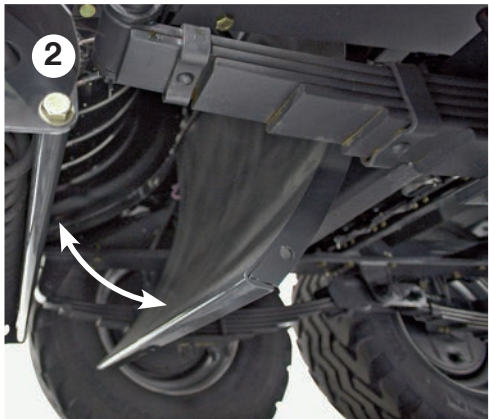

2 Pre-chamber inspection door



OPTIONS



Electric bale length adjustment



Moisture sensor integrated in iso electronics



Bale drop sensor



5

Hinged twine storage boxes for easy machine access



6

High capacity plunger - 46 strokes per minute
12,5 cm diameter plunger rollers



7

3 m (9' 10") bale chamber, with last bale ejection



6

8

7

8



Automatic + manual bale density control



Bale weighing system

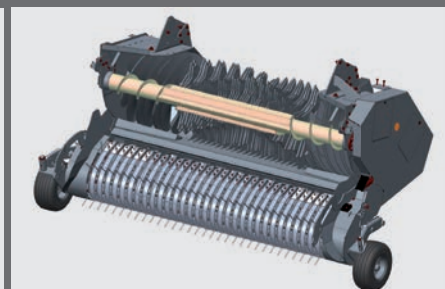

Driven crop roller



Working light options



Easy Flow

FIND THE KUHN LARGE SQUARE BALER, PERFECTLY ADAPTED TO YOUR NEEDS!

Specifications

Bale size		LSB 870	LSB 890 D	LSB 1270	LSB 1270 DX	LSB 1290 D
80 x 70 cm	2 x 3	x				
80 x 90 cm	3 x 3		x			
120 x 70 cm	2 x 4			x	x	
120 x 90 cm	3 x 4					x

Check out the whole KUHN ranges of Balers and BalePack combinations



1. Variable Balers - 2. Variable BalePacks - 3. Fixed Balers - 4. Fixed BalePacks - 5. i-BIO+ - 6. Round and Square Bale Wrappers.

For more information about your nearest KUHN dealer, visit our website www.kuhn.com



Visit us on our YouTube channels.



Your KUHN dealer

www.kuhn.com

KUHN S.A.

4 Impasse des Fabriques - BP 50060
F-67706 Saverne CEDEX - FRANCE

KUHN NORTH AMERICA, INC.

1501 West Seventh Avenue - Brodhead,
WI 53520 - USA

KUHN FARM MACHINERY PTY. LTD

313-325 Foleys Road - Deer Park, VIC, 3023 - AUSTRALIA

KUHN FARM MACHINERY (U.K.) LTD

Stafford Park 7 - GB TELFORD/ SHROPS TF3 3BQ

Information given in this document is only for information purposes and is non-contractual. Our machines are in compliance with regulations in force in the country of delivery. In our literature, and for improved illustration of certain details, some safety devices may not be in operating position. When operating these machines, these devices must be in position in accordance with the requirements indicated in the operator's manuals and assembly manuals. Respect the tractor gross vehicle weight rating, its lift capacity and maximum load per axle and tyres. The tractor front axle load must always comply with the regulations of the country of delivery (In Europe, it must reach minimum 20 % of the tractor net weight). We reserve the right to change any designs, specifications or materials listed without further notice. Machines and equipment in this document can be covered by at least one patent and/or registered design. Trademarks cited in this document may be registered in one or several countries.

Also find KUHN on

