

Kohler® Diesel

Model KDW702

High Speed Open Power Unit

2 Cylinders » 686 cc » 12.5 kW/16.8 HP » 3600 RPM » 29.9 ft. lbs @ 2000 RPM

Certification

EPA TIER 4 ■

Features

- 4-Stroke Diesel Engine with In-Line Cylinders
- Liquid-Cooled with Axial Fan
- Overhead Camshaft
- Indirect Fuel Injection by Unit Injectors
- Double PTO on Crankshaft
- Counter-Clockwise Rotation (From PTO Side)
- Full-Pressure Lubrication
- Full Flow Oil Filter
- Water Pump Driven by Timing Belt
- Automatic Extra Fuel Starting Device
- Variable Speed Governor
- Cast-Iron Crankcase with Re-Borable Cylinders
- Aluminum Cylinder Head

Applications

- Excavator
- Generator
- Refrigeration Unit
- Sweeper
- Access Platform
- Roller
- Power Buggy
- ATV
- APU

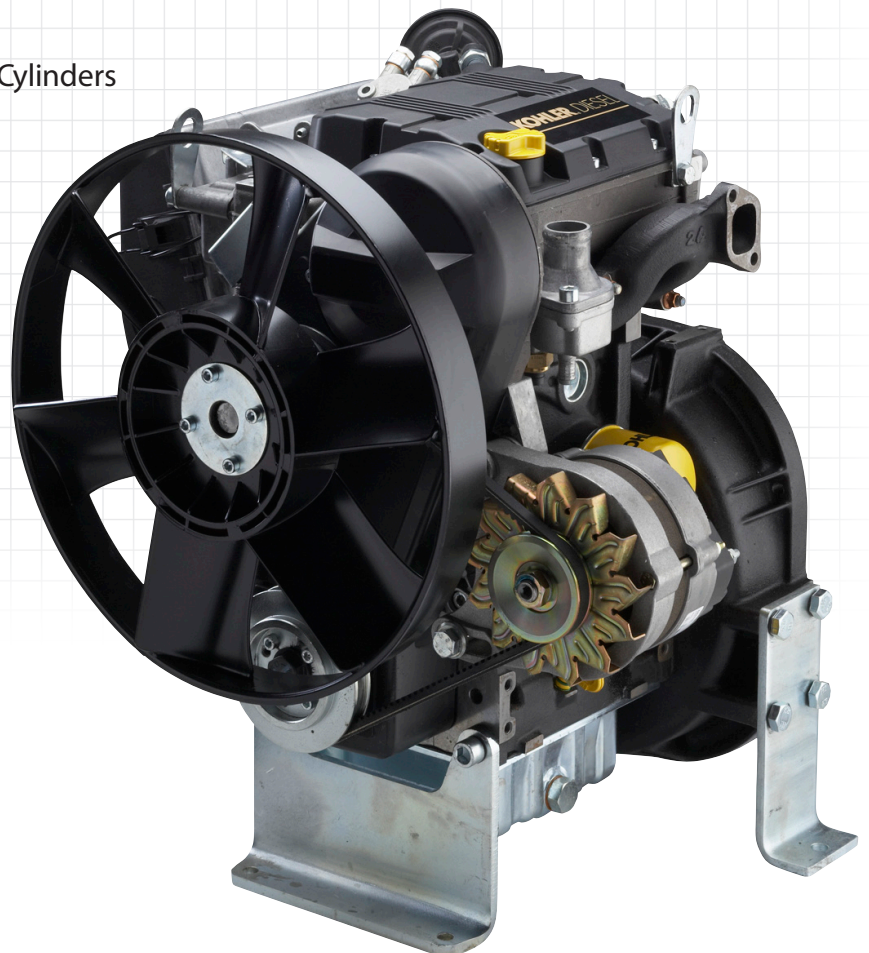

Kohler® Diesel

Model KDW702

High Speed Open Power Unit

Specifications

Cylinders	No. of Cylinders	2
Displacement	cc/cu. in.	686/41.9
Bore	mm/in.	75/3
Stroke	mm/in.	77.6/3.1
Compression Ratio		22.8:1
Rating kW/HP	N (80/1269/CEE) ISO 1585	12.5/16.8
	NB ISO 3046 IFN	11.7/15.7
	NA ISO 3046 ICXN	10.7/14.3
Max. Torque	N·m/ft. lbs. @ 2000 RPM	40.5/29.9
Max. Torque 3 PTO	N·m/ft. lbs.	37/27
Minimum Idling Speed RPM		900
Water Pump Delivery @ 3600 RPM	liters/min/gpm	40/11 (~)
Oil Consumption	kg/lbh	0.009/0.020
Oil Capacity	liters/quarts	1.6/1.7
Min. Allowable Oil Pressure	bar/psi	1.5/21.8
Max. Allowable Angle of Operation (Peak Values)		25° (35°)
Volume of Air Required for Correct Combustion @ 3600 RPM	liters/min/cfm	1240/44
Volume of Air Required for Correct Cooling @ 3600 RPM	m ³ /min/cfm	43/1519
Dry Weight	kg/lbs	104/229.3
Battery	V/Ah	12/44
Minimum Pulley Diameters for Belt Drive		

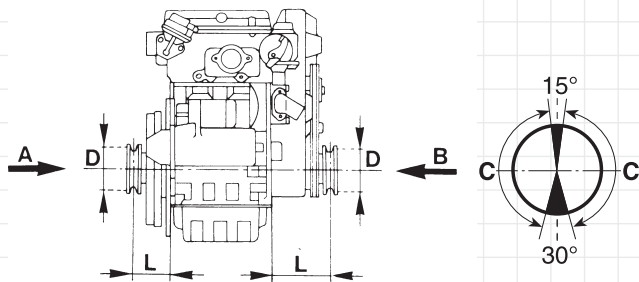

V Belt	$D \text{ (mm)} \geq 143 [L \text{ (mm)} + 101]$	$\frac{N \text{ (kW)}}{n \text{ (RPM)}}$
Cogged Belt	$D \text{ (mm)} \geq 99 [L \text{ (mm)} + 101]$	$\frac{N \text{ (kW)}}{n \text{ (RPM)}}$

Maximum Allowable Axial Load in Both Directions A-B = 300 kg/661 lbs.

C - Allowable Zone for Radial Load

Sound Pressure Level dB (A)

Sound Pressure Level Polar Diagram
Open Field at 7 Meters - No Load
Running Engine.

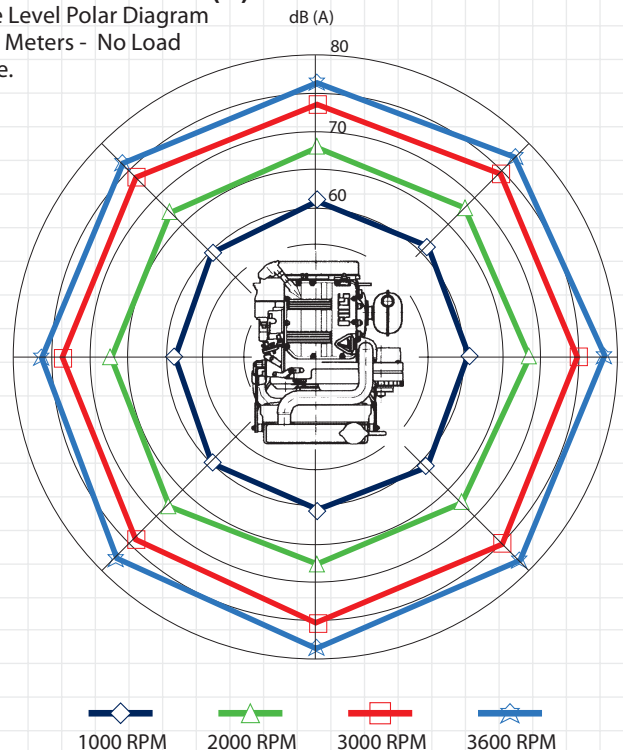

◆ 1000 RPM
 ▲ 2000 RPM
 ■ 3000 RPM
 ★ 3600 RPM

Kohler® Diesel Model KDW702 High Speed Open Power Unit

Curves

KDW702 @ 3600 RPM

KDW702/B1 @ 3000 RPM

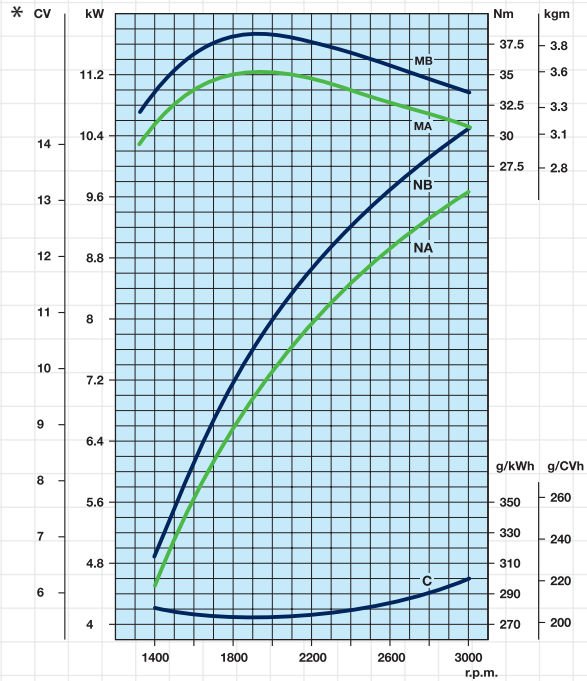
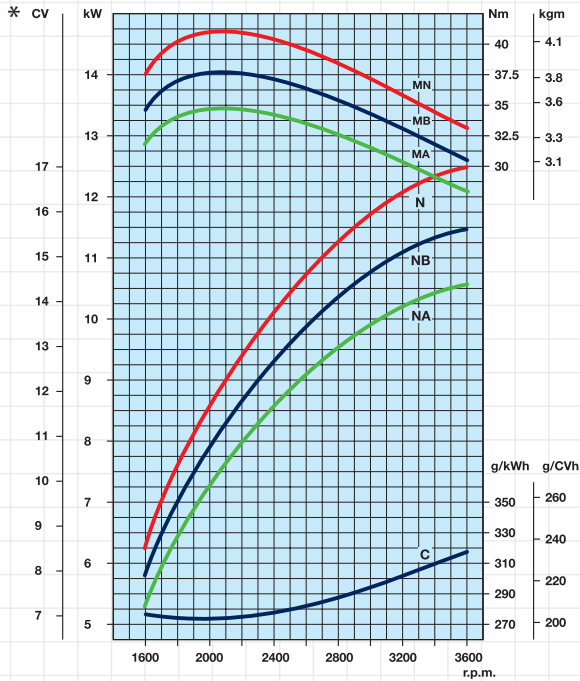

KDW702 @ 3200 RPM

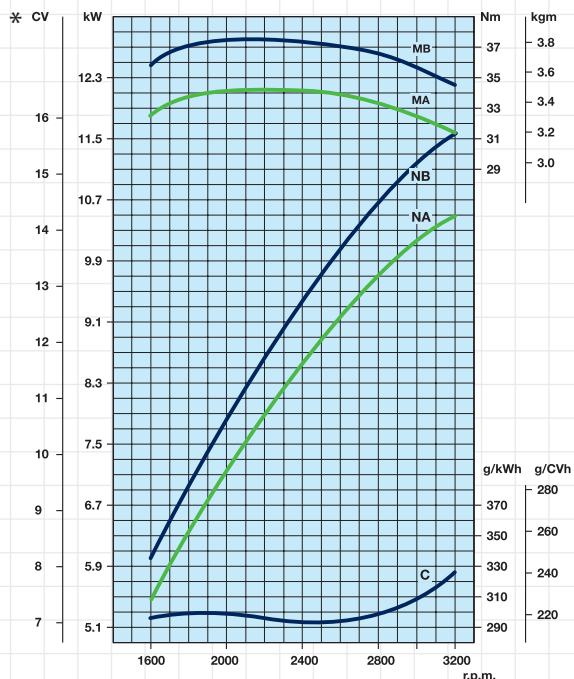

- N Power Curve - 80/1269/CEE - ISO 1585 -
- NB Power Curve - ISO 3046/1 - IFN -
- NA Power Curve - ISO 3046/1 - ICXN -
- MN Torque Curve - (N curve)
- MB (B Curve) - MA (A curve)
- C Specific Fuel Consumption - (NB curve)

Output Power for Fixed Speed Application (Including Generator Sets)

Engine Power kW

RPM	Intermittent (NB)	Continuous (NA)
3600	11.5	10.4
3000	11	10
1800	6.5	5.9
1500	5.5	5

*European Equivalent to HP (1 CV = 0.986 HP)

Kohler® Diesel

Model KDW702

High Speed Open Power Unit

Technical Drawings

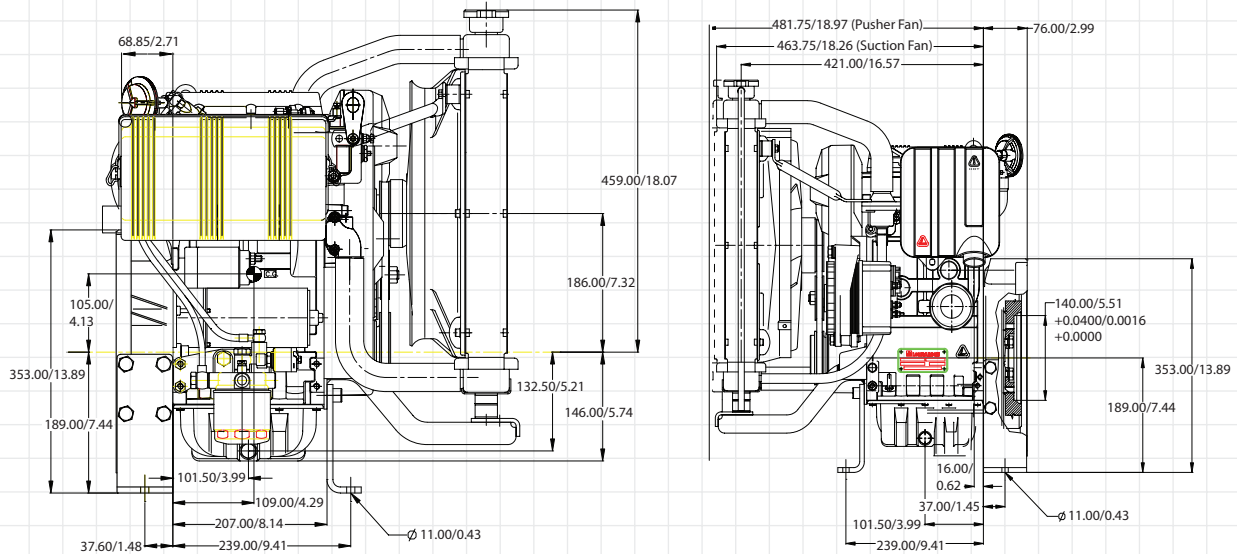

Standard Features (Open Power Unit)

- Base Engine
- Mounted Top Tank Radiator
- Radiator Fan Guard
- Suction Fan
- Mounted Air Cleaner
- Muffler and Guard
- 12 V Electric Starter
- 45 Amp External Alternator
- Fuel Filter with Valve
- Mounting Feet
- Mounted Control Panel
- Group 8 Interchange Housing
- Safety Shutdown for Low Oil Pressure and High Coolant Temperature
- 3600 RPM

Accessories

- SAE Housings and Drives
- Shaft Extensions
- Hydraulic Drives
- Dry Air Cleaners
- Various Mufflers and Manifolds
- Various Muffler Guards and Flanges
- Remote Oil Filter
- Top Tank and Cross-Flow Radiators
- Suction and Pusher Fans
- High-Capacity Oil Sump
- Wiring Harness Extension
- 2nd PTO Two-Groove Pulley
- Extended Dipstick

